

# Table of Contents

## Recessed Section A



## Strips Section B



## Highbays Section C



## Surface Section D



## Specialty Section E



## Vanity Section F



## Retrofits Section G



## Residential Section H



## Savegreen Section K

**SG**

Ask for Savegreen

The Simple LED Solution

**QUIK LED**

The Benefits of LED with  
Ease, Practicality and Flexibility



**Skybox**

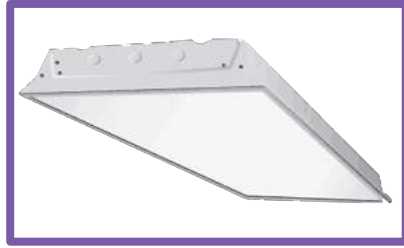

**131 Recessed Troffer**



**Flat Panels**



**Surface Shroud**



**Center Basket**



**Square Lens**



**LED Decorative  
Center Basket**



**Concave Lensed**



**Curve Lit Sides  
Center Basket**



**Dual Lens**



**Deep Cell Parabolic**



**Parabolic**



**Perimeter Lighting**



**Recessed Open Linear**

### Note to our Valued Customers:

As the current climate of tariff policies continues to impact pricing, LITE can be a great resource to help minimize the impact on your purchases. Manufacturing domestically, we have the fixture advantage. We can also recommend or source alternative products that might be more cost effective. Please check with your sales consultant for options and current pricing.

# Sky Box

Our SBX is an architectural and aesthetically pleasing addition to any environment. Not only do we offer our SBX as a whole fixture; we also sell the recessed shroud to transform existing flat panels in your space! This specification grade luminaire is available in 1x4, 2x2, and 2x4 sizes with 3500, 4000, or 5000K Color Temperatures. Our 2x4 boasts an offering of two different Lumen packages. The shroud can be customized to add a pop of color.

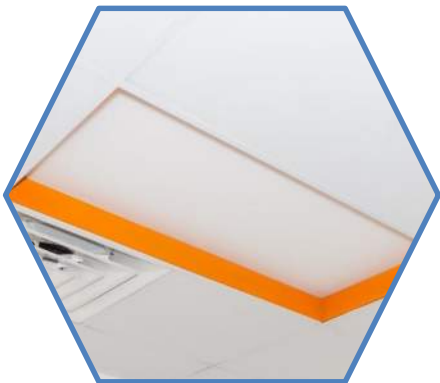
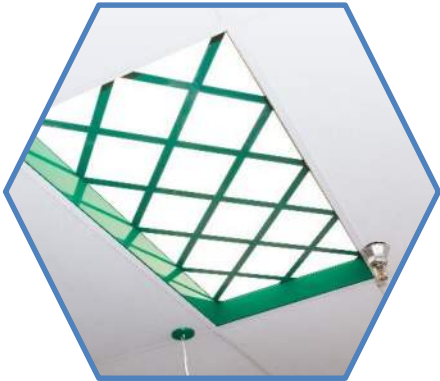

Transform your flat panel into a specification grade luminaire with our Sky Box accessory. Custom interior color makes a statement and reinforces your brand.

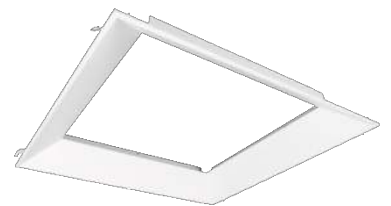

## SKY BOX (Innovative recessed shroud and flat panels combined)

ITEM NO.	DESCRIPTION	SPECIAL PRICE
HLSBX22LED40DMVWH40	2x2 / 40W, 5000L, 4000K, 0-10V Dim, Color Temp - 35,40, 50	CALL
HLSBX14LED40DMVWH40	1x4 / 40W, 5000L, 4000K, 0-10V Dim, Color Temp - 35,40, 50	CALL
HLSBX24LED50DMVWH40	2x4 / 50W, 6250L, 4000K, 0-10V Dim, Color Temp - 35,40, 50	CALL

For Emergency, add EM for \$115.



Create your own Skybox with your existing flat panel – See page A4

LED RECESSED TROFFER



ITEM NO.	DESCRIPTION	SPECIAL PRICE
HSL131A22LJ28W3200LDMV40K*	2x2 / 28W, 3200L / Color Temp - 30, 35, 40, 50	CALL
HSL131A22LJ35W3900LDMV40K*	2x2 / 35W, 3900L / Color Temp - 30, 35, 40, 50	CALL
HSL131A22LJ40W4500LDMV40K*	2x2 / 40W, 4500L / Color Temp - 30, 35, 40, 50	CALL
HSL131A14LJ35W4300LDMV40K*	1x4 / 35W, 4300L / Color Temp - 30, 35, 40, 50	CALL
HSL131A14LJ48W5800LDMV40K*	1x4 / 48W, 5800L / Color Temp - 30, 35, 40, 50	CALL
HSL131A24LJ35W4600LDMV40K*	2x4 / 35W, 4600L / Color Temp - 30, 35, 40, 50	CALL
HSL131A24LV37W4750LDMV40K*	2x4 / 37W, 4750L / Color Temp - 30, 35, 40, 50	CALL
HSL131A24LJ48W6300LDMV40K*	2x4 / 48W, 6300L / Color Temp - 30, 35, 40, 50	CALL
HSL131A24LJ57W7100LDMV40K*	2x4 / 57W, 7100L / Color Temp - 30, 35, 40, 50	CALL

Change lens to Frosted (FR) and add \$8.00.  
 For Surface Mount, add SH to prefix and see shroud pricing A4.  
 Add "R" after 131A for Air Return and add \$10.  
 For A125 Lens add \$4.00.  
 For Dim to 1% up to 57watt, change DMV to D1MV and add \$10.00.  
 For Emergency, add EM for \$115.

Go to DLC Website for Other Wattages and Lumens. DLC nomenclature might be listed under parent company models.

LED RECESSED TROFFER WITH INTEGRAL OCCUPANCY SENSOR



ITEM NO.	DESCRIPTION	SPECIAL PRICE
HSLSM131A22LY28W2825LDMV40K	2x2 / 28W, 2825L / Color Temp - 30, 35, 40, 50 w/ Integral Occupancy Sensor	CALL
HSLSM131A14LY56W5650LDMV40K	1x4 / 56W, 5650L / Color Temp - 30, 35, 40, 50 w/ Integral Occupancy Sensor	CALL
HSLSM131A24LY56W5650LDMV40K	2x4 / 56W, 5650L / Color Temp - 30, 35, 40, 50 w/ Integral Occupancy Sensor	CALL

SM - Microwave Sensor, Leviton OSM3DV1W, Hidden Behind Lens

VL LED TROFFER - SPECIAL PURCHASE (WHILE QUANTITY LAST)



ITEM NO.	DESCRIPTION	SPECIAL PRICE
HSL131A24LY56W5650LVDMV40K**	2x4 / 56W, 5650L / Color Temp - 30, 35, 40, 50	CALL

\*\* Consult for different wattage and color temperature with programmable drivers.

Philips Drivers and LED Arrays



Make Your Fixtures "Smarter" and More Efficient with Sensors

FOR SENSOR OPTIONS:

- ADD PREFIX DESCRIPTION
- SS On / Off
  - SD On / Off, Daylight Harvesting
  - SV On / Variable Setting (DMVXX - XX is % of intensity when dim)
  - SM Microwave Sensor, On / Off - Consult for specific adder for your fixture



## FLAT PANEL LED EDGE LIT (EXTERNAL DRIVER)

ITEM NO.	DESCRIPTION	SPECIAL PRICE
HSLFPELP22LED40DMVWH40*	2x2 / 40W, 5000L, 4000K, 0-10V Dim, Color Temp - 35,40, 50	CALL
HSLFPELP14LED40DMVWH40*	1x4 / 40W, 5000L, 4000K, 0-10V Dim, Color Temp - 35,40, 50	CALL
HSLFPELP24LED50DMVWH40*	2x4 / 50W, 6250L, 4000K, 0-10V Dim, Color Temp - 35,40, 50	CALL
HSLFPELP24LED75DMVWH40	2x4 / 75W, 9375L, 4000K, 0-10V Dim, Color Temp - 40, 50	CALL

For Surface Mount with Shroud -

Add SH in front of item number and add:  
2X4: \$42.80; 1X4: \$37.50; 2X2: \$32.10

Frame-in-kits available to mount in hard ceilings:

FIK2X2: \$18.00; FIK1X4: \$18.00; FIK2X4: \$23.00

DLC nomenclature might be listed under parent company models.

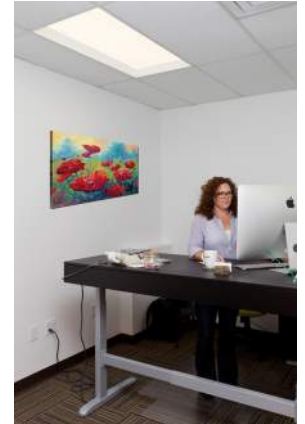

## SKYBOX ACCESSORY (TO USE WITH FLAT PANEL BY OTHERS)

ITEM NO.	DESCRIPTION	SPECIAL PRICE
HLSBXX22	2x2 / 23.95"L x 23.95"W x 3.68"H	CALL
HLSBXX14	1x4 / 47.65"L x 12"W x 3.68"H	CALL
HLSBXX24	2x4 / 47.86"L x 23.95"W x 3.68"H	CALL

See complete fixture on page A2.



## SURFACE SHROUD

(SPECIALLY DESIGNED SHALLOW, CLEAN SHROUD FOR FLAT PANELS)

ITEM NO.	DESCRIPTION	SPECIAL PRICE
HLSHFPELP2X2WH	2x2 / 24"L x 24"W x 3"D	CALL
HLSHFPELP1X4WH	1x4 / 48"L x 12"W x 3"D	CALL
HLSHFPELP2X4WH	2x4 / 48"L x 24"W x 3"D	CALL

Specify Flat Panel separately.



Shown Surface Mount Kit with Flat Panel.



Available with a variety of sensors. Consult for Leviton Intellect Sensor and Control System.



For additional Sensor Options see pag A3.

**SMART LED CENTER LENS W/ SENSOR**

ITEM NO.	DESCRIPTION	SPECIAL PRICE
HSLSSUCLL22LJ28W3150LDMV40K	2x2 / 28W, 3150L / Color Temp - 30, 35, 40,50	CALL
HSLSSUCLL22LJ42W4300LDMV30K	2x2 / 42W, 4300L / Color Temp - 30, 35, 40,50	CALL
HSLSSUCLL14LJ32W4300LDMV40K	1x4 / 32W, 4300L / Color Temp - 30, 35, 40,50	CALL
HSLSSUCLL14LJ48W6000LDMV40K	1x4 / 48W, 6000L / Color Temp - 30, 35, 40,50	CALL
HSLSSUCLL24LJ48W6100LDMV40K	2x4 / 48W, 6100L / Color Temp - 30, 35, 40,50	CALL
HSLSSUCLL24LJ57W6800LDMV40K	2x4 / 57W, 6800L / Color Temp - 30, 35, 40,50	CALL

AIR RETURN Options Available. Check with Factory.

**LED CENTER LENS TROFFER**



Surface mount any recessed by adding "SH" to prefix and consult sales specialist for pricing.

For Emergency, add EM for \$115. Consult for 1x1 and 1x2. For perforated basket change LL to PF. For Dim to 1% up to 57watt, change DMV to D1MV and add \$10.00.

ITEM NO.	DESCRIPTION	SPECIAL PRICE
HSLUCLL22LJ24W2700LDMV40*	2x2 / 24W, 2700L / Color Temp - 30, 35, 40, 50	CALL
HSLUCLL22LJ28W3150LDMV40K*	2x2 / 28W, 3150L / Color Temp - 30, 35, 40, 50	CALL
HSLUCLL22LJ30W3600LDMV40K*	2x2 / 30W, 3600L / Color Temp - 30, 35, 40, 50	CALL
HSLUCLL14LJ32W4300LDMV40K*	1x4 / 32W, 4300L / Color Temp - 30, 35, 40, 50	CALL
HSLUCLL14LJ40W5250LDMV40K*	1x4 / 40W, 5250L / Color Temp - 30, 35, 40, 50	CALL
HSLUCLL14LJ48W6000LDMV40K*	1x4 / 48W, 6000L / Color Temp - 30, 35, 40, 50	CALL
HSLUCLL24LJ32W4350LDMV40K*	2x4 / 32W, 4350L / Color Temp - 30, 35, 40, 50	CALL
HSLUCLL24LJ40W5300LDMV40K*	2x4 / 40W, 5350L / Color Temp - 30, 35, 40, 50	CALL
HSLUCLL24LJ48W6100LDMV40K*	2x4 / 48W, 6100L / Color Temp - 30, 35, 40, 50	CALL
HSLUCLL24LJ57W7680LDMV40K*	2x4 / 57W, 6800L / Color Temp - 30, 35, 40, 50	CALL

**LED CENTER LENS TROFFER - AIR RETURN**

ITEM NO.	DESCRIPTION	SPECIAL PRICE
HSLUCRLL22LF28W3200LDMV40K	2x2 / 28W, 3200L / Color Temp - 30, 35, 40,50	CALL
HSLUCRLL22LH35W4200LDMV40K	2x2 / 35W, 4200L / Color Temp - 30, 35, 40,50	CALL
HSLUCRLL24LF48W6750LDMV40K	2x4 / 48W, 6750L / Color Temp - 30, 35, 40,50	CALL
HSLUCRLL24LF57W7800LDMV40K	2x4 / 57W, 7800L / Color Temp - 30, 35, 40,50	CALL

**VL LED CENTER LENS**



ITEM NO.	DESCRIPTION	SPECIAL PRICE
HSLCBF22LF28W3200LDMV40K*	2x2 / 28W, 3200L / 0-10V Dim / 4000K	CALL
HSLCBF22LF35W4200LDMV40K*	2x2 / 35W, 4200L / 0-10V Dim / 4000K	CALL
HSLCBF14LF35W4600DMV40K*	1x4 / 35W, 4600L / 0-10V Dim / 4000K	CALL
HSLCBF14LF48W6000DMV40K*	1x4 / 48W, 6000L / 0-10V Dim / 4000K	CALL
HSLCBF24LF35W4500LDMV40K*	2x4 / 35W, 4500L / 0-10V Dim / 4000K	CALL
HSLCBF24LF48W6200LDMV40K*	2x4 / 48W, 6200L / 0-10V Dim / 4000K	CALL
HSLCBF24LF57W7200LDMV40K*	2x4 / 57W, 7200L / 0-10V Dim / 4000K	CALL



## LED CENTER SQUARE LENS

ITEM NO.	DESCRIPTION	SPECIAL PRICE
HSLSCB22LV22W2200LDMV40K	2x2 / 22W, 2200L, 4000K, 0-10V Dim	CALL
HSLSCB22LV30W3000LDMV40K	2x2 / 30W, 3000L, 4000K, 0-10V Dim	CALL
HSLSCB14LV37W3300LDMV40K	1x4 / 37W, 3300L, 4000K, 0-10V Dim	CALL
HSLSCB14LV57W4700LDMV40K	1x4 / 57W, 4700L, 4000K, 0-10V Dim	CALL
HSLSCB24LV46W4000LDMV40K	2x4 / 46W, 4000L, 4000K, 0-10V Dim	CALL
HSLSCB24LV57W4800LDMV40K	2x4 / 57W, 4800L, 4000K, 0-10V Dim	CALL



## LED DECORATIVE CENTER BASKET



ITEM NO.	DESCRIPTION	SPECIAL PRICE
HSLLXT22LZ24W3000LDMV40K*	2x2 / 24W, 3000L / Color Temp 30, 35, 40, 50	CALL
HSLLXT22LZ36W4200LDMV40K*	2x2 / 36W, 4200L / Color Temp 30, 35, 40, 50	CALL
HSLLXT24LZ45W5800LDMV40K*	2x4 / 45W, 5800L / Color Temp 30, 35, 40, 50	CALL
HSLLXT24LZ60W7350LDMV40K*	2x4 / 60W, 7350L / Color Temp 30, 35, 40, 50	CALL

For Emergency, add EM for \$115. Consult for different wattage and color temperature.

NOTE: See HSL LXT Cut Sheet for additional Wattage and Lumen Options.



## LED CONCAVE LENSED



ITEM NO.	DESCRIPTION	SPECIAL PRICE
HSLVLT22LJ36W3700LDMV40K	2x2 / 36W, 3700L / Color Temp 30, 35, 40, 50	CALL
HSLVLT24LJ48W5500LDMV40K	2x4 / 48W, 5500L / Color Temp 30, 35, 40, 50	CALL
HSLVLT24LJ52W5100LDMV40K*	2x4 / 52W, 5100L / Color Temp 35, 40 For	CALL

Emergency, add EM for \$115. Consult for different wattage and color temperature.

## SMART LED LINEAR RECESSED W/ SENSOR



ITEM NO.	DESCRIPTION	SPECIAL PRICE
HSLSSVLT22LJ24W2600LDMV40K	2 x 2 / 24W, 2600L / Color Temp - 30, 35, 40, 50	CALL
HSLSSVLT22LJ36W3700LDMV40K	2 x 2 / 36W, 3700L / Color Temp - 30, 35, 40, 50	CALL
HSLSSVLT14LJ35W4100LDMV40K	1 x 4 / 35W, 4100L / Color Temp - 30, 35, 40, 50	CALL
HSLSSVLT14LJ48W5100LDMV40K	1 x 4 / 48W, 5100L / Color Temp - 30, 35, 40, 50	CALL
HSLSSVLT24LJ35W3700LDMV40K	2x4 / 35W, 3700L / Color Temp - 30, 35, 40, 50	CALL
HSLSSVLT24LJ48W5100LDMV40K	2x4 / 48W, 5100L / Color Temp - 30, 35, 40, 50	CALL
HSLSSVLT24LJ52W6000LDMV40K	2x4 / 52W, 6000L / Color Temp - 30, 35, 40, 50	CALL

For additional Sensor Options see page A3. For Emergency, add EM for \$115.

Smart Fixtures with Sensors are ideal for applications with irregular usage like bathrooms, closets, conference rooms and circulation spaces.

**LED CURVE LIT SIDES CENTER BASKET**



Lit acrylic sides add premium look over standard Center Basket fixtures

ITEM NO.	DESCRIPTION	SPECIAL PRICE
HSLCRVRL22LJ28W3500LDMV40K	2x2 / 28W, 3500L / Color Temp 30, 35, 40, 50	CALL
HSLCRVRL22LJ35W4200LDMV40K	2x2 / 35W, 4200L / Color Temp 30, 35, 40, 50	CALL
HSLCRVRL24LJ32W4000LDMV40K	2x4 / 32W, 4000L / Color Temp 30, 35, 40, 50	CALL
HSLCRVRL24LJ48W6100LDMV40K	2x4 / 48W, 6100L / Color Temp 30, 35, 40, 50	CALL
HSLCRVRL24LJ57W7200LDMV40 K	2x4 / 57W, 7200L / Color Temp 30, 35, 40, 50	CALL

For Emergency, add EM for \$115.

**LED DUAL LENS**



ITEM NO.	DESCRIPTION	SPECIAL PRICE
HSLUDLL22LJ28W3200LDMV40K	2x2 / 28W, 3200L / Color Temp 30, 35, 40, 50	CALL
HSLUDLL22LJ35W4200LDMV40K	2x2 / 35W, 4200L / Color Temp 30, 35, 40, 50	CALL
HSLUDLL24LJ48W6000LDMV40K	2x4 / 48W, 6000L / Color Temp 30, 35, 40, 50	CALL
HSLUDLL24LJ57W7100LDMV40K	2x4 / 57W, 7100L / Color Temp 30, 35, 40, 50	CALL

**LED RECESSED PARABOLIC**



ITEM NO.	DESCRIPTION	SPECIAL PRICE
HSLPARA9C22LJ30W2600LDMV40K	2x2/ 9 Cell / 30W, 2600L / 0-10V Dim / 4000K	CALL
HSLPARA9C22LJ42W3300LDMV40K	2x2/ 9 Cell / 42W, 3300L / 0-10V Dim / 4000K	CALL
HSLPARA12C14LJ48W4500LDMV40K	2x4 / 12 Cell / 48W, 4500L / 0-10V Dim / 4000K	CALL
HSLPARA12C14LJ60W5000LDMV40K	2x4 / 12 Cell / 60W, 5000L / 0-10V Dim / 4000K	CALL
HSLPARA18C24LJ48W4500LDMV40K	2x4 / 18 Cell / 48W, 4500L / 0-10V Dim / 4000K	CALL
HSLPARA18C24LJ60W5000LDMV40K	2x4 / 18 Cell / 60W, 5000L / 0-10V Dim / 4000K	CALL
HSLPARA18C24LJ85W7400LDMV40K	2x4 / 18 Cell / 85W, 7400L / 0-10V Dim / 4000K	CALL

Add Frosted Overlay to Hide LED's. Add FR after PARA and add \$5 for 2x2 and \$8 for 2x4.

For Emergency, add EM for \$115.

**LED PARABOLIC WHITE LOUVER (HIGH EFFICIENCY)**



ITEM NO.	DESCRIPTION	SPECIAL PRICE
HSLPEW9C22LJ24W3000LDMV40K	2 x 2 / 9 Cell /24W, 3000L / Color Temp - 30, 35, 40, 50	CALL
HSLPEW9C22LJ30W3600LDMV40K	2 x 2 / 9 Cell /30W, 3600L / Color Temp - 30, 35, 40, 50	CALL
HSLPEW18C24LJ48W6000LDMV40K	2 x 4 / 18 Cell /48W, 6000L / Color Temp - 30, 35, 40, 50	CALL
HSLPEW18C24LJ60W7300LDMV40K	2 x 4 / 18 Cell /60W, 7300L / Color Temp - 30, 35, 40, 50	CALL

Add Frosted Overlay to Hide LED's. Add FR after PEW and add \$5 for 2x2 and \$8 for 2x4. Consult for Louver Options. For semi-specular louver change PEW to PES. For Emergency, add EM for \$115.





## PERIMETER LIGHTING

ITEM NO.	DESCRIPTION	SPECIAL PRICE
HSLEWW24LJ24W1600LDMV40K	Wall Wash 24 In, 24W/ 2400 Lumens; 30K,35K, 40K, 50K	CALL
HSLEWW24LZ35W2500LDMV40K	Wall Wash 24 In, 35W/ 400 Lumens; 30K,35K, 40K, 50K	CALL
HSLEWW48LJ48W3500LDMV40K	Wall Wash 48 In, 24W/ 2400 Lumens; 30K,35K, 40K, 50K	CALL
HSLEWW48LZ57W4000LDMV40K	Wall Wash 48 In, 48W/ 4800 Lumens; 30K,35K, 40K, 50K	CALL

For Emergency, add EM for \$115.

## RECESSED OPEN LINEAR (IDEAL FOR GENERAL MERCHANDISING)

ITEM NO.	DESCRIPTION	SPECIAL PRICE
HSLITB48LT23W3000LDMV40K	4ft. Recessed Linear 23W, 3000L/ Color Temp - 30, 35, 40, 50	CALL
HSLITB48LT48W6300LDMV40K	4ft. Recessed Linear 48W, 6300L/ Color Temp - 30, 35, 40, 50	CALL
HSLITB96LT48W6300LDMV40K	8ft. Recessed Linear 48W, 6300L/ Color Temp - 30, 35, 40, 50	CALL
HSLITB96LT85W11000LDMV40K	8ft. Recessed Linear 85W, 11000L/ Color Temp - 30, 35, 40, 50	CALL





**Industrial Strips**



**Economy Lensed**



**Linear Strip Workhorse**



**Linear Strip**



**SER Contoured Strip**



**Linear Round Strip**



**SKD Low Profile**



**CRSR Premium Strip**



**SES**



**CStrip**



**SStrip**



**KDS**



**SSSES**



**SSSKD**



**SMF**

### Note to our Valued Customers:

As the current climate of tariff policies continues to impact pricing, LITE can be a great resource to help minimize the impact on your purchases. Manufacturing domestically, we have the fixture advantage. We can also recommend or source alternative products that might be more cost effective. Please check with your sales consultant for options and current pricing.



# Industrial Strips

Your Choice for Industrial Lighting with LED.

LED Industrials provide more light on the cartons on each side of the aisle.



## INDUSTRIAL STRIP FAMILY (1 STYLE, 3 CONFIGURATIONS)

ITEM NO.	DESCRIPTION	SPECIAL PRICE
<b>Enclosed with Hinged Frosted Lens</b>		
HSLRRSFR48LE28W2700LDMV40K	48" Enclosed w/ FR Hinged Lens 28W/ 2700L	CALL
HSLRRSFR48LE48W4600LDMV40K	48" Enclosed w/ FR Hinged Lens 48W/ 4600L	CALL
HSLRRSFR48LE57W5400LDMV40K	48" Enclosed w/ FR Hinged Lens 57W/ 5400L	CALL
HSLRRSFR96LE57W5400LDMV40K	96" Enclosed w/ FR Hinged Lens 57W/ 5400L	CALL
HSLRRSFR96LE96W9200LDMV40K	96" Enclosed w/ FR Hinged Lens 96W/ 9200L	CALL
HSLRRSFR96LE114W10400LDMV40K	96" Enclosed w/ FR Hinged Lens 114W/ 10400L	CALL
<b>Deep Enhanced White Reflector</b>		
HSLRRS48LE28W4600LW30DMV40K	48" with White Reflector 28W / 4600L	CALL
HSLRRS48LE48W5650LW30DMV40K	48" with White Reflector 48W / 5650L	CALL
HSLRRS48LE57W6400LW30DMV40K	48" with White Reflector 57W / 6400L	CALL
HSLRRS96LE57W6400LW30DMV40K	96" with White Reflector 57W/ 6400L	CALL
HSLRRS96LE96W11300LW30DMV40K	96" with White Reflector 96W/ 11300L	CALL
HSLRRS96LE114W12800LW30DMV40K	96" with White Reflector 114W/ 12800L	CALL
<b>Open Strip</b>		
HSLRRS48LE28W4300LDMV40K	48" Open 28W /4300L	CALL
HSLRRS48LE48W7000LDMV40K	48" Open 48W /7000L	CALL
HSLRRS48LE57W8000LDMV40K	48" Open 57W /8000L	CALL
HSLRRS96LE57W8000LDMV40K	96" Open 57W /8000L	CALL
HSLRRS96LE96W12000LDMV40K	96" Open 96W /12000L	CALL
HSLRRS96LE114W13800LDMV40K	96" Open 114W /13800L	CALL

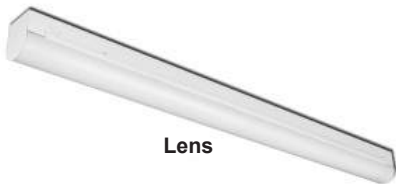

Available in 3000K, 3500K and 5000K. For Emergency, add EM and \$115. Consult for other sizes.

**INDUSTRIAL LED (IDEAL FOR CEILINGS BETWEEN 10 AND 18 FEET)**



ITEM NO.	SIZE (W X L)	Watts / Lumens	Color Options (X100 Kelvins)	SPECIAL PRICE
HSLIND48LJ32W5000LW30DMV40K	10" x 48"	32 / 5000	30, 35, 40, 50	CALL
HSLIND48LJ48W6900LW30DMV40K	10" x 48"	48 / 6900	30, 35, 40, 50	CALL
HSLIND48LJ57W7800LW30DMV40K	10" x 48"	57 / 7800	30, 35, 40, 50	CALL
HSLIND96LJ57W7800LW30DMV40K	10" x 96"	57 / 7800	30, 35, 40, 50	CALL
HSLIND96LJ97W12400LW30DMV40K	10" x 96"	97 / 12400	30, 35, 40, 50	CALL
HSLIND96LJ114W14000LW30DMV40K	10" x 96"	114 / 14000	30, 35, 40, 50	CALL

For Emergency, add EM and \$115. Add wire guard IND48WGWH and \$8.00 per 4 ft.

For continuous run applications add wiring harnesses for electrical plug and play, see Page E10.

**ECONOMY LENSED STRIP (IDEAL FOR COVE LIGHTING)**



ITEM NO.	SIZE (W X L)	Watts / Lumens	Color Options (X100 Kelvins)	SPECIAL PRICE
HSLRKDFR24LJ12W1200LDMV40KWH	2" x 24"	12 / 1200	30, 35, 40, 50	CALL
HSLRKDFR24LJ24W2400LDMV40KWH	2" x 24"	24 / 2400	30, 35, 40, 50	CALL
HSLRKDFR48LJ28W2800LDMV40KWH	2" x 46"	28 / 2800	30, 35, 40, 50	CALL
HSLRKDFR48LZ48W4800LDMV40KWH	2" x 46"	48 / 4800	30, 35, 40, 50	CALL
HSLRKDFR96LJ57W5700LDMV30KWH	2" x 92"	57 / 5700	30, 35, 40, 50	CALL
HSLRKDFR96LZ96W9600LDMV40KWH	2" x 92"	96 / 9600	30, 35, 40, 50	CALL

For Continuous runs add PI1 \$9.95 or PI3D \$11.95 after DMV for Electrical Connector. For Emergency, add EM and \$115.

**LINEAR STRIP WORKHORSE (IDEAL FOR CONTINUOUS RUNS)**



ITEM NO.	DESCRIPTION	SPECIAL PRICE
HSLFSFFR48LJ31W3400LDMV40KWH	2.36"W x 47.25"L x 2.83"H / 31W, 3400L, 4000K	CALL
HSLFSFFR48LZ57W6300LDMV40KWH	2.36"W x 47.25"L x 2.83"H / 57W, 6300L, 4000K	CALL
HSLFSFFR96LJ62W6600LDMV40KWH	2.36"W x 94.43"L x 2.83"H / 62W, 6600L, 4000K	CALL
HSLFSFFR96LZ114W12600LDMV40KWH	2.36"W x 94.43"L x 2.83"H / 114W, 12600L, 4000K	CALL

For Sensor Option add SM in front and \$35.00 or MDT4 \$36.00. For Emergency, add EM and \$115.

For continuous run applications add wiring harnesses for electrical plug and play, see Page E10.

**LINEAR STRIP (IDEAL REPLACEMENT FOR FLUORESCENT STRIPS)**

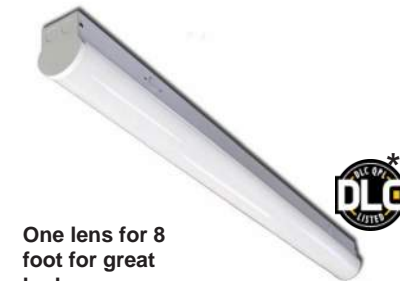

ITEM NO.	DESCRIPTION	SPECIAL PRICE
HSLJSR48L40W5400LDMV40K*	42.44"L x 3.75"H x 3.25"W / 40W, 5400L, 4000K	CALL
HSLJSR96L60W8400LDMV40K*	90.47"L x 3.75"H x 3.25"W / 60W, 8400L, 4000K	CALL
HSLJSR96L68W9400LDMV40K*	90.47"L x 3.75"H x 3.25"W / 68W, 9400L, 4000K	CALL

Change 40K to 35K or 50K. For Emergency, add EM and \$115.

Pendant mount available. Available in 3000K, 3500K, and 5000K.

One lens for 8 foot for great look.

## LED Designer Strips

Ideal for All Applications

Dress up your linear strip with a “hot” color that will attract attention in your space. We can powder coat to any finish with an economical adder

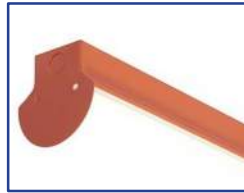
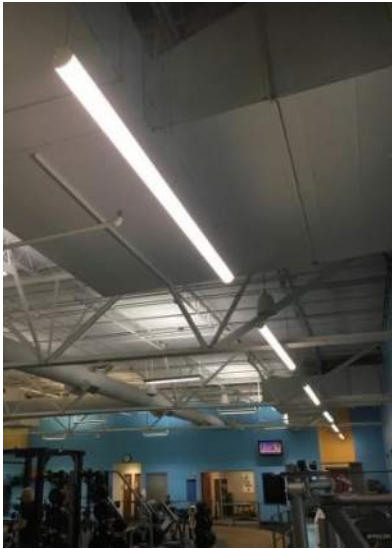

Orange (OR)



Red (RD)



Matte White (WH)



Black (BK)

### LED CONTOURED STRIP

Wall or Ceiling mount, surface or pendant mounted, vertical or horizontal this fixture available standard in 3 sizes can be used individually or joined together for a continuous run. Standard in white but with a variety of finish options. Eight foot has one piece lens for great look. See page E10 for continuous run wiring harness.



ITEM NO.	DESCRIPTION	SPECIAL PRICE
HLSERFR24LR14W1400LDMV40KWH	3.79"W x 23.60"L x 3.93"H / 14W, 1400L, 4000K	CALL
HLSERFR24LR20W2000LDMV40KWH	3.79"W x 23.60"L x 3.93"H / 20W, 2000L, 4000K	CALL
HLSERFR48LT28W3600LDMV40KWH*	3.79"W x 47.20"L x 3.93"H / 28W, 3600L, 4000K	CALL
HLSERFR48LT36W4500LDMV40KWH*	3.79"W x 47.20"L x 3.93"H / 36W, 4500L, 4000K	CALL
HLSERFR96LT56W7500LDMV40KWH*	3.79"W x 94.40"L x 3.93"H / 56W, 7500L, 4000K	CALL
HLSERFR96LT84W11000LDMV40KWH*	3.79"W x 94.40"L x 3.93"H / 84W, 11000L, 4000K	CALL

### with SENSOR

HLSSSERFR24LR14W1400LDMV40KWH	3.79"W x 23.60"L x 3.93"H / 14W, 1400L, 4000K	
HLSSSERFR24LR20W2000LDMV40KWH	3.79"W x 23.60"L x 3.93"H / 20W, 2000L, 4000K	
HLSSSERFR48LT28W3600LDMV40KWH*	3.79"W x 47.20"L x 3.93"H / 28W, 3600L, 4000K	CALL
HLSSSERFR48LT36W4500LDMV40KWH*	3.79"W x 47.20"L x 3.93"H / 36W, 4500L, 4000K	
HLSSSERFR96LT56W7500LDMV40KWH*	3.79"W x 94.40"L x 3.93"H / 56W, 7500L, 4000K	
HLSSSERFR96LT84W11000LDMV40KWH*	3.79"W x 94.40"L x 3.93"H / 84W, 11000L, 4000K	

For Emergency, add EM and \$115.

Check DLC listing for most current/additional Wattage and Lumen Options.

**LINEAR ROUND STRIP (IDEAL FOR VANITY LIGHTING)**

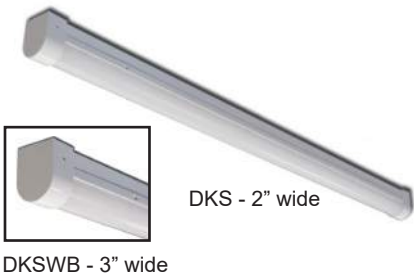

ITEM NO.	DESCRIPTION	SPECIAL PRICE
HSLDKSMW24LZ18W1900LDMV40KWH	2 ft x 2" / 18W, 1900L / Color Temp - 30, 35, 40, 50	CALL
HSLDKSMW48LZ35W3800LDMV40KWH	4 ft x 2" / 35W, 3500L / Color Temp - 30, 35, 40, 50	CALL
HSLDKSWBMW48LZ40W4000LDMV40KWH	4 ft x 3" / 40W, 4000L / Color Temp - 30, 35, 40, 50	CALL
HSLDKSWBMW96LZ80W8000LDMV40KWH	8 ft x 3" / 80W, 8000L / Color Temp - 30, 35, 40, 50	CALL

For emergency, add EM and \$115 (only to WB). Available in BN, BK or BZ and consult for adder. Consult for other wattages & lumens.

New Designer White Ends ideal for variety of applications.

**LOW PROFILE LINEAR STRIP**



ITEM NO.	SIZE (W X L)	Watts / Lumens	Color Options (X100 Kelvins)	SPECIAL PRICE
HLSKDFR24LJ12W1200LDMV40KWH	2" x 22.5"	12 / 1200	30, 35, 40, 50	CALL
HLSKDFR48LJ28W2800LDMV40KWH	2" x 46"	28 / 2800	30, 35, 40, 50	CALL
HLSKDFR48LJ35W3400LDMV40KWH	2" x 46"	35 / 3400	30, 35, 40, 50	CALL
HLSKDFR96LJ57W5400LDMV40KWH	2" x 92"	57 / 5400	30, 35, 40, 50	CALL
HLSKDFR96LJ72W7000LDMV40KWH	2" x 92"	72 / 7000	30, 35, 40, 50	CALL

Only available with remote EM.

Consult for other finishes and adder.

**WIDE BODY LINEAR STRIP (3 INCH WIDE X 3 INCH HEIGHT)**



ITEM NO.	DESCRIPTION	SPECIAL PRICE
HLSKDWBFR24LJ35W3400LDMV40KWH	2 ft / 35W, 3400L / Color Temp 30, 35, 40, 50	CALL
HLSKDWBFR48LJ40W4000LDMV40KWH	4 ft / 40W, 4000L / Color Temp 30, 35, 40, 50	CALL
HLSKDWBFR48LZ72W7000LDMV40KWH	4 ft / 72W, 7000L / Color Temp 30, 35, 40, 50	CALL
HLSKDWBFR96LJ80W8000LDMV40KWH	8 ft / 80W, 8000L / Color Temp 30, 35, 40, 50	CALL
HLSKDWBFR96LZ114W10800LDMV40KWH	8 ft / 114W, 10800L / Color Temp 30, 35, 40, 50	CALL

For Brushed Nickel, Change WH to BN and Add \$15 per 4 ft. For Bronze, Change WH to BZ and add \$15. For Emergency, add EM and \$115. For Sensor Option add "SD" in front and \$35.00

Vented body is for Emergency Version.

**LED PREMIUM STRIP (IDEAL FOR CONTINUOUS RUNS)**



ITEM NO.	DESCRIPTION	SPECIAL PRICE
HSLCRSR48LT30W3500LDMV40K*	4.36"W x 48"L x 3.90"H/ ROUND LENS/ 30W, 3500L, 4000K	CALL
HSLCRSR48LT41W4300LDMV40K*	4.36"W x 48"L x 3.90"H/ ROUND LENS/ 41W, 4300L, 4000K	CALL
HSLCRSR48LT58W6700LDMV40K*	4.36"W x 48"L x 3.90"H/ ROUND LENS/ 58W, 6700L, 4000K	CALL
HSLCRSR96LT60W6900LDMV40K*	4.36"W x 96"L x 3.90"H/ ROUND LENS/ 60W, 6900L, 4000K	CALL
HSLCRSR96LT82W8900LDMV40K*	4.36"W x 96"L x 3.90"H/ ROUND LENS/ 82W, 8900L, 4000K	CALL
HSLCRSR96LT116W13400LDMV40K*	4.36"W x 96"L x 3.90"H/ ROUND LENS/ 116W, 13400L, 4000K	CALL
HSLCRSF48LT30W3500LDMV40K	4.36"W x 48"L x 3.90"H/ FLAT LENS/ 30W, 3500L, 4000K	CALL
HSLCRSF48LT41W4300LDMV40K	4.36"W x 48"L x 3.90"H/ FLAT LENS/ 41W, 4300L, 4000K	CALL
HSLCRSF48LT58W6700LDMV40K	4.36"W x 48"L x 3.90"H/ FLAT LENS/ 58W, 6700L, 4000K	CALL
HSLCRSF96LT60W6900LDMV40K	4.36"W x 96"L x 3.90"H/ FLAT LENS/ 60W, 6900L, 4000K	CALL
HSLCRSF96LT82W8900LDMV40K	4.36"W x 96"L x 3.90"H/ FLAT LENS/ 82W, 8900L, 4000K	CALL
HSLCRSF96LT116W13400LDMV40K	4.36"W x 96"L x 3.90"H/ FLAT LENS/ 116W, 13400L, 4000K	CALL

For Emergency, add EM and \$115.

Check DLC listing for most current/additional Wattage and Lumen Options.

Fully luminous lens from end to end.

This fixture is also DLC listed with a Flat Lens Option. (See picture above.)





## LINEAR FIXTURE

ITEM NO.	DESCRIPTION	SPECIAL PRICE
HLSSESFR48LS31W3100LDMV40KWH	2.36"W x 47.25"L x 2.83"H / 31W, 3100L, 4000K	CALL
HLSSESFR48LR40W4000LDMV40KWH	2.36"W x 47.25"L x 2.83"H / 40W, 4000L, 4000K	CALL
HLSSESFR96LS62W6200LDMV40KWH	2.36"W x 94.43"L x 2.83"H / 62W, 6200L, 4000K	CALL
HLSSESFR96LR80W8000LDMV40KWH	2.36"W x 94.43"L x 2.83"H / 80W, 8000L, 4000K	CALL

Pendant mount available. Available in 3000K, 3500K, and 5000K. For Side Mount version with downlight change SES to SESW.

## LINEAR FIXTURE w/ SENSOR (FIXTURE ON WHEN OCCUPIED, OFF WHEN NOT)

ITEM NO.	DESCRIPTION	SPECIAL PRICE
HSLSSSESFR24LH20W2000LDMV40KWH	2.36"W x 23.6"L x 2.83"H / 20W, 2000L, 4000K	CALL
HSLSSSESFR48LS31W3100LDMV40KWH	2.36"W x 47.25"L x 2.83"H / 31W, 3200L, 4000K	CALL
HSLSSSESFR96LS62W6200LDMV40KWH	2.36"W x 94.43"L x 2.83"H / 62W, 6200L, 4000K	CALL
HSLSSSESFR24LH20W2000LSTMV40KWH	2.36" x 23.6", 20W 2000L with 50% Step Dim	CALL
HSLSSSESFR48LS31W3100LSTMV40KWH	2.36" x 47.3", 31W 3100L with 50% Step Dim	CALL
HSLSSSESFR96LS62W6200LSTMV40KWH	2.36" x 94.43", 62W 6200L with 50% Step Dim	CALL

Step Dim w/Sensor (Fixture ON when occupied, 50% when not). Consult for other finishes. Pendant mount available. Available in 3000K, 3500K, and 5000K. Other Sensor Options See Page A3.

\$99 w/ Sensor

## LED OPEN STRIP (4.25" WIDE) (CONSULT TO ADD REFLECTORS)

ITEM NO.	DESCRIPTION	SPECIAL PRICE
HSLC24LF24W3350LDMV40K*	4.25" x 24" / 24W, 3350L, 4000K	CALL
HSLC24LF30W3900LDMV40K*	4.25" x 24" / 30W, 3900L, 4000K	CALL
HSLC48LF35W4900LDMV40K*	4.25" x 48" / 35W, 4900L, 4000K	CALL
HSLC48LF48W6500LDMV40K*	4.25" x 48" / 48W, 6500L, 4000K	CALL
HSLC48LF57W7800LDMV40K*	4.25" x 48" / 57W, 7800L, 4000K	CALL
HSLC96LF70W9800LDMV40K*	4.25" x 96" / 70W, 9800L, 4000K	CALL
HSLC96LF97W13000LDMV40K*	4.25" x 96" / 97W, 13000L, 4000K	CALL
HSLC96LF118W15500LDMV40K*	4.25" x 96" / 118W, 15500L, 4000K	CALL



## LED LENSED STRIP (4.25" WIDE)

ITEM NO.	DESCRIPTION	SPECIAL PRICE
HSLC24LFRF24W3000LDMV40K*	4.25" x 24" / 24W, 3000L, 4000K	CALL
HSLC24LFRF30W3400LDMV40K*	4.25" x 24" / 30W, 3400L, 4000K	CALL
HSLC48LFRF35W4500LDMV40K*	4.25" x 48" / 35W, 4500L, 4000K	CALL
HSLC48LFRF48W6000LDMV40K*	4.25" x 48" / 48W, 6000L, 4000K	CALL
HSLC48LFRF57W7100LDMV40K*	4.25" x 48" / 57W, 7100L, 4000K	CALL
HSLC96LFRF70W9100LDMV40K*	4.25" x 96" / 70W, 9100L, 4000K	CALL
HSLC96LFRF97W11900LDMV40K*	4.25" x 96" / 97W, 11900L, 4000K	CALL
HSLC96LFRF118W14200LDMV40K*	4.25" x 96" / 118W, 14200L, 4000K	CALL



For Wire Guard add WG and \$8.00. For Emergency, add EM and \$115. Check DLC listing for most current/additional Wattage and Lumen Options.

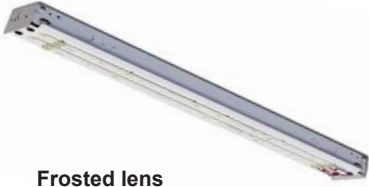

Frosted lens accessory reduces LED brightness. S48FRLN - \$8.50

**LED OPEN STRIP (2.75" WIDE)**

ITEM NO.	DESCRIPTION	SPECIAL PRICE
HSLS24LS12W1400LDMV40K	2.75" x 1.80" x 24.00" / 12W, 1400L, 4000K	CALL
HSLS48LS24W2800LDMV40K	2.75" x 1.80" x 48.00" / 24W, 2800L, 4000K	CALL
HSLS48LS28W3200LDMV40K	2.75" x 1.80" x 48.00" / 28W, 3200L, 4000K	CALL
HSLS48LH35W3400LDMV40K	2.75" x 1.80" x 48.00" / 35W, 3400L, 4000K	CALL
HSLS96LS57W6400LDMV40K	2.75" x 1.80" x 96.00" / 57W, 6400L, 4000K	CALL
HSLS96LH72W8200LDMV40K	2.75" x 1.80" x 96.00" / 72W, 8200L, 4000K	CALL

**LED STRIP WITH REFLECTOR (IDEAL FOR WALL WASHING)**

ITEM NO.	DESCRIPTION	SPECIAL PRICE
HSLS24LR15W1600LW35DMV40K	24" STRIP ASYMMETRICAL REFLECTOR 15W 1600 LUMENS 4000K	CALL
HSLS48LR29W3200LW35DMV40K	48" STRIP ASYMMETRICAL REFLECTOR 29W 3200 LUMENS 4000K	CALL
HSLS60LR38W4070LW35DMV40K	60" STRIP ASYMMETRICAL REFLECTOR 38W 4070 LUMENS 4000K	CALL
HSLS96LR57W6400LW35DMV40K	96" STRIP ASYMMETRICAL REFLECTOR 57W 6400 LUMENS 4000K	CALL

Available in 3000K, 3500K, and 5000K. For continuous run, see wiring harness on page E10.



Asymmetrical reflector provides wall wash (W35 Reflector)



Create perimeter lighting and brand image. Consult for custom fixtures and finishes.

**LED OPEN STRIP (1.62" WIDE) IDEAL FOR COVES**

ITEM NO.	DESCRIPTION	SPECIAL PRICE
HSLKDS48LJ24W2800LDMV40K	1.62" x 1.62" x 48.00" / 24W, 2800L, 4000K	CALL
HSLKDS48LJ28W3200LDMV40K	1.62" x 1.62" x 48.00" / 28W, 3200L, 4000K	CALL
HSLKDS48LJ35W4000LDMV40K	1.62" x 1.62" x 48.00" / 35W, 4000L, 4000K	CALL
HSLKDS96LJ48W5650LDMV40K	1.62" x 1.62" x 96.00" / 48W, 5650L, 4000K	CALL
HSLKDS96LJ57W6400LDMV40K	1.62" x 1.62" x 96.00" / 57W, 6400L, 4000K	CALL
HSLKDS96LJ72W7000LDMV40K	1.62" x 1.62" x 96.00" / 72W, 7000L, 4000K	CALL

Available in 3000K, 3500K and 5000K. Add Wiring Harness for Continuous Runs - See Page E10.

For Emergency, add EM and \$115.







## LED LINEAR w/DAYLIGHT HARVESTING SENSOR

ITEM NO.	DESCRIPTION	SPECIAL PRICE
HLSLSDSEFR24LJ20W2000LDMV40KWH	2.36" x 23.6", 20W 2000L, Daylight Harvesting	CALL
HLSLSDSEFR48LJ31W3100LDMV40KWH	2.36" x 47.3", 31W 3100L, Daylight Harvesting	CALL
HLSLSDSEFR96LJ62W6200LDMV40KWH	2.36" x 94.43", 62W 6200L, Daylight Harvesting	CALL

SD - Daylight Harvesting Sensor in conjunction with 0-10V driver allow light level to adjust to ambient light. Available in 3000K, 3500K, and 5000K.

## WIDE BODY LINEAR STRIP w/SENSOR (FIXTURE ON WHEN OCCUPIED, OFF WHEN NOT)

ITEM NO.	DESCRIPTION	SPECIAL PRICE
HSLSSSKDWBFR24LH35W3400LDMV40KWH	2 ft / 35W, 3400L / Color Temp 30, 35, 40, 50	CALL
HSLSSSKDWBFR48LE40W4000LDMV40KWH	4 ft / 40W, 4000L / Color Temp 30, 35, 40, 50	CALL
HSLSSSKDWBFR48LH72W7000LDMV40KWH	4 ft / 72W, 7000L / Color Temp 30, 35, 40, 50	CALL
HSLSSSKDWBFR96LH80W8000LDMV40KWH	8 ft / 80W, 8000L / Color Temp 30, 35, 40, 50	CALL
HSLSSSKDWBFR96LE114W10800LDMV40KWH	8 ft / 114W, 10800L / Color Temp 30, 35, 40, 50	CALL

## LINEAR FIXTURE w/MICROWAVE SENSOR

ITEM NO.	DESCRIPTION	SPECIAL PRICE
HLSMFSFFR48LF31W3100LDMV40KWH	2.36"W x 47.25"L x 2.83"H / 31W, 3200L, 4000K	CALL
HLSMFSFFR96LF62W6200LDMV40KWH	2.36"W x 94.43"L x 2.83"H / 62W, 6200L, 4000K	CALL

For Emergency, add EM and \$115. NOTE: Center shadow for microwave sensor.

### Dimming to 1%

Standard DMV provides dimming to 10% intensity.  
For Dim to 1% up to 57watt, change DMV to D1MV and add \$10.00.

From design, to your site. We help you complete the Job, at the speed of LITE!

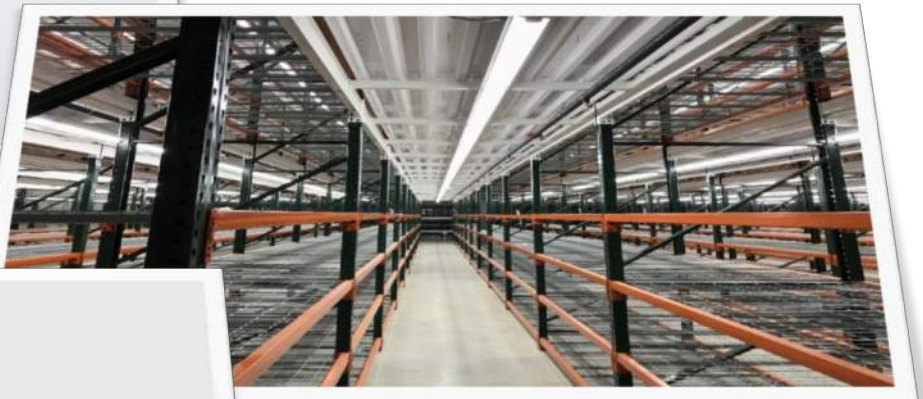

Photos from previous job sites. Fixtures supplied by LITE.



## Note to our Valued Customers:

As the current climate of tariff policies continues to impact pricing, LITE can be a great resource to help minimize the impact on your purchases. Manufacturing domestically, we have the fixture advantage. We can also recommend or source alternative products that might be more cost effective. Please check with your sales consultant for options and current pricing.



**Premium High Bay**



**HIL High Bay**



**HBG High Bay**



**HBC High Bay**



**HBCA Aisle Light**



**Mini High Bay**



**Round High Bay**





**Vapor Tight High Bay High Bay**



**Vapor Tight High Bay Low Bay**

## Evolution of a High Bay Leader (From HID to LED)

Evolution of the High Bay			
	<b>HID</b>	<b>FLUORESCENT</b>	<b>LED</b>
<b>ENERGY</b>	460 Watts	324 Watts	216 Watts
<b>LIFE</b>	20,000 Hours	30,000 Hours	50,000 hour
<b>MAINTENANCE</b>	Re-Lamp and Re-Ballast	Re-Lamp and Re-Ballast	Replace Driver

### LED PREMIUM HIGH BAY w/OPTIONAL ACCESSORIES



ITEM NO.	DESCRIPTION	SPECIAL PRICE
HSLHBIP12L110W14680LMV50K*	11.8"Wx21.5"Lx2"H High Bay 110W, 14680 Lumens 50K	CALL
HSLHBIP22L165W22000LMV50K*	16.0"Wx21.5"Lx2"H High Bay 165W, 22000 Lumens 50K	CALL
HSLHBIP24L220W29370LMV50K**	11.8"Wx43"Lx2"H High Bay 220W 29370 Lumens 50K	CALL

For Emergency, add EM for \$115. For Occupancy Sensor, add MDT4 and \$36. Fixtures include chain kits. Consult for different wattage, color temperature, and higher lumens.



### HIGH OUTPUT PREMIUM LED HIGH BAY

ITEM NO.	DESCRIPTION	SPECIAL PRICE
HSLHBIHO24L245W34300LDMV50K*	20"Wx43"Lx1.5"H High Output High Bay 245W, 34300 LUMEN 50K	CALL
HSLHBIHO24L325W45500LDMV50K*	20"Wx43"Lx1.5"H High Output High Bay 325W, 45500 LUMEN 50K	CALL

Consult for 200W.

### ACCESSORIES

Fine tune your High Bay to your application.



Door Frame Lens options.

ITEM NO.	DESCRIPTION	SPECIAL PRICE
HSLHBI12DFMW	1x2** High Bay Door Frame Set w/ Matte White Lens	CALL
HSLHBI22DFMW	2x2** High Bay Door Frame Set w/ Matte White Lens	CALL
HSLHBI24DFMW	2x4** High Bay Door Frame Set w/ Matte White Lens	CALL
HSLHBI12WG	1x2 Wire Guard White	CALL
HSLHBI22WG	2x2 Wire Guard White	CALL
HSLHBI24WG	2x4 Wire Guard White	CALL
HSLHBI12FMK	Flush Mounting Kit 6"L x 2"W x 0.8"H	CALL
HSLHBI24FMK	Flush Mounting Kit 6"L x 2"W x 0.8"H	CALL
HSLHBIPDMK	Pendant Mounting Kit 3.4"L x 2.3"W x 2"H	CALL



For lensed version add FR after HIL.



### LED HIGH BAY (OPTIONAL LENS)

ITEM NO.	DESCRIPTION	SPECIAL PRICE
HSLHIL24LY80W10000LDMV50K	24"L 80W AND 10,000 LUMENS 50K	CALL
HSLHIL24LY122W15000LDMV50K	24"L 122W AND 15,000 LUMENS 50K	CALL
HSLHIL48LY80W10000LDMV50K	45"L 80W AND 10,000 LUMENS 50K	CALL
HSLHIL48LY122W15000LDMV50K	45"L 122W AND 15,000 LUMENS 50K	CALL
HSLHIL48LA149W20000LDMV50K	45"L 149W AND 20,000 LUMENS 50K	CALL
HSLHIL48LA175W25000LDMV50K*	45"L 175W AND 25,000 LUMENS 50K	CALL
HSLHIL48LA215W30000LDMV50K*	45"L 215W AND 30,000 LUMENS 50K	CALL
HSLHIL48LA260W35000LDMV50K*	45"L 260W AND 35,000 LUMENS 50K	CALL
HSLHIL48LA280W40000LDMV50K*	45"L 280W AND 40,000 LUMENS 50K	CALL
HSLHIL48LA315W45000LDMV50K*	45"L 315W AND 45,000 LUMENS 50K	CALL
HSLHIL48LA355W50000LDMV50K*	45"L 335W AND 50,000 LUMENS 50K	CALL

Available in 3000K, 3500K and 4000K. For Frosted Lens add "FR" after HIL and \$10 on 2x2 and \$15 on 2x4. For Clear Lens change FR to CL and add \$5 on 2x2 and \$10 on 2x4. For Wireguard add WG after FR and \$15 on 2x2 and \$19 on 2x4. For Occupancy Sensor on End add MDT4 and \$36. For Emergency, add EM for \$115.

Check DLC listing for most current/additional Wattage and Lumen Options.

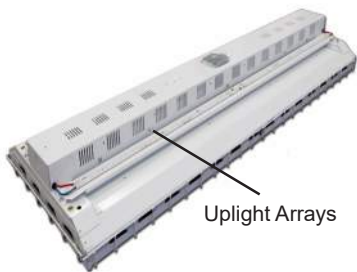

Uplight Arrays

### UPLIGHT ACCESSORY FOR HIL

ITEM NO.	DESCRIPTION	SPECIAL PRICE
HSLUV45W	Uplight Accessory Module 45W and 5500 Lumens to either 2x2 or 2x4	CALL

LED Arrays don't provide the 360 degrees light output of fluorescent lamps. For applications that require uplight, this accessory is ideal. Consult for other wattages and lumens.

### HIGH BAY WITH AIMABLE AND MODULAR ARRAYS

ITEM NO.	DESCRIPTION	SPECIAL PRICE
HSLHBG48LD104W15000LDHV50K*	20"Wx46"L / 104W, 15000L Color Temp 30, 35, 40, 50	CALL
HSLHBG48LD132W20000LDHV50K*	20"Wx46"L / 132W, 20000L Color Temp 30, 35, 40, 50	CALL
HSLHBG48LD175W25000LDHV50K*	20"Wx46"L / 175W, 25000L Color Temp 30, 35, 40, 50	CALL
HSLHBG48LD215W30000LDHV50K*	20"Wx46"L / 215W, 30000L Color Temp 30, 35, 40, 50	CALL
HSLHBG48LD280W40000LDMV50K*	20"Wx46"L / 280W, 40000L Color Temp 30, 35, 40, 50	CALL
HSLHBG48LD355W50000LDMV50K*	20"Wx46"L / 355W, 50000L Color Temp 30, 35, 40, 50	CALL

Shown with Sensor.

Each of the Four Linear LEDs are Separately Enclosed and Aimable.

Consult for 2 Row Version.



### with SENSOR

HSLSSHBG48LD104W15000LDMV50K*	20"Wx46"L / 104W, 15000L Color Temp 30, 35, 40, 50	CALL
HSLSSHBG48LD132W20000LDMV50K*	20"Wx46"L / 132W, 20000L Color Temp 30, 35, 40, 50	CALL
HSLSSHBG48LD175W25000LDMV50K*	20"Wx46"L / 175W, 25000L Color Temp 30, 35, 40, 50	CALL
HSLSSHBG48LD215W30000LDMV50K*	20"Wx46"L / 215W, 30000L Color Temp 30, 35, 40, 50	CALL
HSLSSHBG48LD280W40000LDMV50K*	20"Wx46"L / 280W, 40000L Color Temp 30, 35, 40, 50	CALL
HSLSSHBG48LD355W50000LDMV50K*	20"Wx46"L / 355W, 50000L Color Temp 30, 35, 40, 50	CALL

Add "FR" after HBG for Frosted Lens and add \$24.00 for 104W to 215W \$32.00 for 280W \$40.00 to 355W. This fixture series available in HV (347v/480v)

Check DLC listing for most current/additional Wattage and Lumen Options.

**The Next Generation of High Bays is Here**





Add Wire Guard, without door, with WG at end of item number and add \$16.  
Add to door frame for \$12.



### LENS OPTIONS

(See Width Description Above for Correct Version)

## HIGH BAY (Most Popular High Bay Style for 6 Years)

ITEM NO.	DESCRIPTION	SPECIAL PRICE
HSLHBC48LN127W18000LA10DMV50K*	16"Wx48"L / 127W, 18000L Color Temp 30, 35, 40, 50	CALL
HSLHBC48LN162W24000LA10DMV50K*	16"Wx48"L / 162W, 24000L Color Temp 30, 35, 40, 50	CALL
HSLHBC48LN216W30000LA10DMV50K*	16"Wx48"L / 216W, 30000L Color Temp 30, 35, 40, 50	CALL
HSLHBC48LN272W36000LA10DMV50K*	16"Wx48"L / 272W, 36000L Color Temp 30, 35, 40, 50	CALL

## LOW BAY

ITEM NO.	DESCRIPTION	SPECIAL PRICE
HSLHBC48LS61W7040LW30DMV40K	10"Wx48"L / 61W, 7040L Color Temp 30, 35, 40, 50	CALL
HSLHBC48LF97W11300LW30DMV40K*	16"Wx48"L / 97W, 11300L Color Temp 30, 35, 40, 50	CALL
HSLHBC48LH118W13500LW30DMV50K*	16"Wx48"L / 118W, 13500L Color Temp 30, 35, 40, 50	CALL

Check DLC listing for most current/ additional Wattage and Lumen Options. For Emergency, add EM for \$115.

### See Accessories & Options Below

	HBC10"	HBC16"
Clear Lens Wraps Around Body	HBC10CL - \$15.00	HBC16CL \$18.00
Frosted Lens Wraps Around Body	HBC10FR - \$14.00	HBC16FR \$16.00
Door Frame with Clear Lens*	DFCL - \$25	DFCL - \$30
Door Frame with Frosted Lens*	DFFR - \$20	DFFR - \$25



Big Job or small,  
We help you  
**LITE** it all!

Previous Job Site Photos.  
Fixtures supplied by LITE.



## ASLE LIGHT



Shown with Optional Wire Guard

ITEM NO.	DESCRIPTION	SPECIAL PRICE
4FT		
HSLHBCA48LN110W14000LA10DMV50K	8"Wx48"L / 110W, 14000L Color Temp 30, 35, 40, 50	CALL
HSLHBCA48LN144W20000LA10DMV50K	8"Wx48"L / 144W, 20000L Color Temp 30, 35, 40, 50	CALL
8FT		
HSLHBCA96LN162W22000LA10DMV50K	8"Wx96"L / 162W, 22000L Color Temp 30, 35, 40, 50	CALL
HSLHBCA96LN220W27000LA10DMV50K	8"Wx96"L / 220W, 27000L Color Temp 30, 35, 40, 50	CALL
HSLHBCA96LN288W35000LA10DMV50K	8"Wx96"L / 288W, 35000L Color Temp 30, 35, 40, 50	CALL

For Wire Guard Add WG and \$14.00. Consult for other wattage and lumen packages.



Shown with Door Frame and Lens

## MINI HIGH BAY

ITEM NO.	DESCRIPTION	SPECIAL PRICE
HSLHBC22LN63W9000LA10DMV50K	20"Wx24"L / 63W, 9000L Color Temp 30, 35, 40, 50	CALL
HSLHBC22LN110W16000LA10DMV50K	20"Wx24"L / 110W, 16000L Color Temp 30, 35, 40, 50	CALL
HSLHBC22LN144W20000LA10DMV50K	20"Wx24"L / 144W, 20000L Color Temp 30, 35, 40, 50	CALL

For Door Frame and Lens add DFFR and \$25.00

**HIGH BAY ACCESSORY OPTIONS**



ITEM NO.	DESCRIPTION	SPECIAL PRICE
HSLMDT4	External Mounted Occupancy Sensor	CALL
HSLWG	Wire Guard for HBC Full Size	CALL
HSLGT310	Gripple Style Cable Kit 10 FT	CALL
HSLHC101	Chain Kit - 4 "S" Hooks & 20 FT Chain	CALL
HSLEM	Emergency Driver	CALL
HSLHBC7	Center Hub for 3/4" Pipe	CALL

**ROUND HIGH BAY**



ITEM NO.	DESCRIPTION	SPECIAL PRICE
HSLRHB15L100W14000LDMV50K*	15.56"Dia x 7.08"H 100W / 14000 Lumen, 120V-277V, 5000K	CALL
HSLRHB15L180W25000LDMV50K*	15.56"Dia x 7.08"H 180W / 25000 Lumen, 120V-277V, 5000K	CALL
HSLSVRHB15L100W14000LDMV50K*	15.56"Dia x 7.08"H 100W / 14000 Lumen, 120V-277V, 5000K w/Integrated Photo/Motion Sensor	CALL
HSLSVRHB15L180W25000LDMV50K*	15.56"Dia x 7.08"H 180W / 25000 Lumen, 120V-277V, 5000K w/Integrated Photo/Motion Sensor	CALL

**VAPOR TIGHT HIGH BAY WET LOCATION**

(IDEAL FOR COLD STORAGE AND WASH DOWN)



ITEM NO.	DESCRIPTION	SPECIAL PRICE
HSLCITACL48LV80W9700LDMV50K	51.87"L x 14.44"W x 4.63"H / Clear with Matt White Ends Lens / 80W, 9700L / 5000K	CALL
HSLCITACL48LA120W15500LDMV50K	51.87"L x 14.44"W x 4.63"H / Clear with Matt White Ends Lens / 120W, 15500L / 5000K	CALL
HSLCITACL48LA140W18000LDMV50K	51.87"L x 14.44"W x 4.63"H / Clear with Matt White Ends Lens / 140W, 18000L / 5000K	CALL
HSLCITACL48LA150W19500LDMV50K	51.87"L x 14.44"W x 4.63"H / Clear with Matt White Ends Lens / 150W, 19500L / 5000K	CALL
HSLCITACL48LA180W21500LDMV50K	51.87"L x 14.44"W x 4.63"H / Clear with Matt White Ends Lens / 180W, 21500L / 5000K	CALL

For Emergency, add EM and \$115. See specification sheet for mounting options and accessories. CL is Clear Acrylic Lens, change to FR for Frosted Acrylic Lens. For Polycarbonate Versions add PC after CL or FR. Available in 3000K, 3500K and 4000K. Consult your sales specialist for DLC listed options.

**VAPOR TIGHT LOW BAY WET LOCATION**

(IDEAL FOR COLD STORAGE AND WASH DOWN) IP65, IP66 IP67, NEMA4X



ITEM NO.	DESCRIPTION	SPECIAL PRICE
HSLCITACL24LV80W8000LDMV50K	26.6"L x 14.5"W x 5.8"H, Clear with Frosted Ends Lens 80W / 8000L	CALL
HSLCITACL24LV100W10000LDMV50K	26.6"L x 14.5"W x 5.8"H, Clear with Frosted Ends Lens 100W / 10000L	CALL
HSLCITACL24LV140W14000LDMV50K	26.6"L x 14.5"W x 5.8"H, Clear with Frosted Ends Lens 140W / 14000L	CALL

For Emergency, add EM and \$115. See specification sheet for mounting options and accessories. CL is Clear Acrylic Lens, change to FR for Frosted Acrylic Lens. For Polycarbonate Versions add PC after CL or FR. Available in 3000K, 3500K and 4000K.



## Note to our Valued Customers:

As the current climate of tariff policies continues to impact pricing, LITE can be a great resource to help minimize the impact on your purchases. Manufacturing domestically, we have the fixture advantage. We can also recommend or source alternative products that might be more cost effective. Please check with your sales consultant for options and current pricing.



**Low Profile Surface Flat Panel**

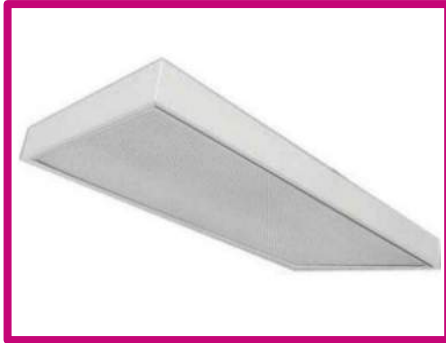

**Surface Troffer**



**Engineered Wraparound**



**Wraparound 7"**



**Wraparound 9"**



**209 Wide Wraparound**



**201 Narrow Wraparound**



**Corridor Linear**



**Linear Wall Washer**



**Linear Strip Cove**



**Linkable LED Strip**



**Strip With Reflector**

**PREMIUM LOW PROFILE WELDED SURFACE FLAT PANEL**

Most shroud kits for flat panels have unsightly seams in the corners. This welded body encloses Flat Panel without visual seams and requires no tools to install.



ITEM NO.	DESCRIPTION	SPECIAL PRICE
HLSLHPFPELP22LED40DMVWH40	2x2 / 40W, 5000L, 4000K, 0-10V Dim, Color Temp - 35,40, 50	CALL
HLSLHPFPELP14LED40DMVWH40	1x4 / 40W, 5000L, 4000K, 0-10V Dim, Color Temp - 35,40, 50	CALL
HLSLHPFPELP24LED50DMVWH40	2x4 / 50W, 6250L, 4000K, 0-10V Dim, Color Temp - 35,40, 50	CALL

**SURFACE SHROUD FOR FLAT PANELS**

This specially designed shroud kit allows most flat panels to be surface mounted with a sleek, fresh appearance.



ITEM NO.	DESCRIPTION	SPECIAL PRICE
HLSLHPFPELP22WH	2x2x3.5" Deep Surface Kit for Most 2x2 Flat Panels	CALL
HLSLHPFPELP14WH	1x4x3.5" Deep Surface Kit for Most 1x4 Flat Panels	CALL
HLSLHPFPELP24WH	2x4x3.5" Deep Surface Kit for Most 2x4 Flat Panels	CALL

For economy shroud see page A4. Order flat panels separately.

**LED SURFACE TROFFER (WELDED SEAMLESS BODY)**

ITEM NO.	SIZE (W X L)	Watts / Lumens	Color Options (X100 Kelvins)	SPECIAL PRICE
HSL153A22LJ24W2700LDMV40K	2 x 2	24 / 2700	30, 35, 40, 50	CALL
HSL153A22LJ28W3200LDMV40K	2 x 2	28 / 3200	30, 35, 40, 50	CALL
HSL153A22LJ35W3900LDMV40K	2 x 2	35 / 3900	30, 35, 40, 50	CALL
HSL153A14LJ35W4300LDMV40K	1 x 4	35 / 4300	30, 35, 40, 50	CALL
HSL153A14LJ48W5800LDMV40K	1 x 4	48 / 5800	30, 35, 40, 50	CALL
HSL153A24LJ35W4600LDMV40K	2 x 4	35 / 4600	30, 35, 40, 50	CALL
HSL153A24LJ48W6300LDMV40K	2 x 4	48 / 6300	30, 35, 40, 50	CALL
HSL153A24LJ57W7100LDMV40K	2 x 4	57 / 7100	30, 35, 40, 50	CALL

For Emergency, add EM for \$115. Dress up with higher efficiency. Frosted Lens made special for LED. Replace "A" with "FR" and add \$8.00.

**ENGINEERED WRAPAROUND WITH SOLID ENDS**

Heavy duty construction ideal for individual or continuous runs.



ITEM NO.	DESCRIPTION	SPECIAL PRICE
HSLEWPLR48LS32W4200LDMV40K	9.56"W x 48.0"L x 3.19"H , 32 Watts, 4200 Lumens/ Avail 30K, 35K, 40K, 50K	CALL
HSLEWPLR48LS48W5800LDMV40K	9.56"W x 48.0"L x 3.19"H , 48 Watts, 5800 Lumens/ Avail 30K, 35K, 40K, 50K	CALL
HSLEWPLR48LH72W8700LDMV40K	9.56"W x 48.0"L x 3.19"H , 72 Watts, 8700 Lumens/ Avail 30K, 35K, 40K, 50K	CALL
HSLEWPLR96LS48W5800LDMV40K	9.56"W x 96.0"L x 3.19"H , 48 Watts, 5800 Lumens/ Avail 30K, 35K, 40K, 50K	CALL
HSLEWPLR96LS65W8400LDMV40K	9.56"W x 96.0"L x 3.19"H ,65 Watts, 8400 Lumens/ Avail 30K, 35K, 40K, 50K	CALL
HSLEWPLR96LS97W11600LDMV40K	9.56"W x 96.0"L x 3.19"H , 97 Watts, 11600 Lumens/ Avail 30K, 35K, 40K, 50K	CALL

For Emergency, add EM for \$115. For wiring harness for continuous run, see page E10.



Consult for 8ft. LED Wrap.

**NEW Frosted Lens**

## LED WRAPAROUND 7"

ITEM NO.	SIZE (W X L)	SPECIAL PRICE
HSL207FR224LS24W2800LDMV40K	7.625"W" x 24"L x 3"H / 24W, 2800L, 4000K	CALL
HSL207FR224LS30W3300LDMV40K	7.625"W" x 24"L x 3"H / 30W, 3300L, 4000K	CALL
HSL207FR248LS32W4000LDMV40K	7.625"W" x 48"L x 3"H / 32W, 4000L, 4000K	CALL
HSL207FR248LS48W5500LDMV40K	7.625"W" x 48"L x 3"H / 48W, 5500L, 4000K	CALL
HSL207FR248LS57W6300LDMV40K	7.625"W" x 48"L x 3"H / 57W, 6300L, 4000K	CALL
HSL207FR448LS65W8100LDMV40K	13"W" x 48"L x 3"H / 65W, 8100L, 4000K	CALL
HSL207FR448LS97W11200LDMV40K	13"W" x 48"L x 3"H / 97W, 11200L, 4000K	CALL

For Emergency, add EM for \$115. Available in 3000K, 3500K and 5000K.



**NEW Frosted Lens**



## LED WRAPAROUND 9"

ITEM NO.	SIZE (W X L)	Watts / Lumens	Color Options (X100 Kelvins)	SPECIAL PRICE
HSL209A24LF18W2400LDMV40K*	9" x 24"	18 / 2400	30, 35, 40, 50	CALL
HSL209A24LF30W3600LDMV40K*	9" x 24"	30 / 3600	30, 35, 40, 50	CALL
HSL209FR48LF57W6700LDMV40K	9" x 48"	57 / 6700	30, 35, 40, 50	CALL
HSL209FR48LH72W9000LDMV40K	9" x 48"	72 / 9000	30, 35, 40, 50	CALL
HSL209A48LF32W3450LDMV40K*	9" x 48"	32 / 3450	30, 35, 40, 50	CALL
HSL209A48LV37W4500LDMV40K*	9" x 48"	37 / 4500	30, 35, 40, 50	CALL
HSL209A48LV45W4900LDMV40K	9" x 48"	45 / 4900	30, 35, 40, 50	CALL

For Emergency, add EM for \$115.

Check DLC listing for most current/additional Wattage and Lumen Options.

## LED Wraparound



ITEM NO.	DESCRIPTION	SPECIAL PRICE
HSL207A224LV22W2650LDMV40K*	24"L x 7.625"W x 3"H / 22W, 2650L / 0-10V Dim / 40K	CALL
HSL207A248LV37W4500LDMV40K*	48"L x 7.625"W" x 3"H / 37W, 4500L / 0-10V Dim / 40K	CALL

For Emergency, add EM for \$115. Acrylic Lens' above.

## SPECIFICATION GRADE WIDE WRAPAROUND (4 SIZES)



8 FT Size Available

ITEM NO.	DESCRIPTION	SPECIAL PRICE
HSL200A224LS28W2700LDMV40K	24"L x 11.25"W x 3.4"H / Acrylic Lens / 28W, 3300L / 0-10V Dim, Avail 30K, 35K, 40K, 50K	CALL
HSL200A424LS48W6000LDMV40K	24"L x 15.80"W x 3.4"H / Acrylic Lens / 48W, 6000L / 0-10V Dim, Avail 30K, 35K, 40K, 50K	CALL
HSL200A248LS48W5600LDMV40K	48"L x 11.25"W x 3.4"H / Acrylic Lens / 48W, 5600L / 0-10V Dim, Avail 30K, 35K, 40K, 50K	CALL
HSL200A248LS57W6500LDMV40K	48"L x 11.25"W x 3.4"H / Acrylic Lens / 57W, 6500L / 0-10V Dim, Avail 30K, 35K, 40K, 50K	CALL
HSL200A448LS72W9500LDMV40K	48"L x 15.80"W x 3.4"H / Acrylic Lens / 72W, 8200L / 0-10V Dim, Avail 30K, 35K, 40K, 50K	CALL
HSL200A296LS97W11200LDMV40K	96"L x 11.25"W x 3.4"H / Acrylic Lens / 97W, 11200L / 0-10V Dim, Avail 30K, 35K, 40K, 50K	CALL
HSL200A296LS114W13000LDMV40K	96"L x 11.25"W x 3.4"H / Acrylic Lens / 114W, 13000L / 0-10V Dim, Avail 30K, 35K, 40K, 50K	CALL

For Emergency, add EM for \$115.

**NARROW WRAPAROUND LED (IDEAL FOR CORRIDORS & SMALLER AREAS)**



ITEM NO.	DESCRIPTION	SPECIAL PRICE
HSL201A48LS24W2800LDMV40K	48"L x 5.75"W x 4.6"H / Acrylic Lens / 24W, 2800L / 0-10V Dim	CALL
HSL201A48LS32W4000LDMV40K	48"L x 5.75"W x 4.6"H / Acrylic Lens / 32W, 4000L / 0-10V Dim	CALL
HSL201A48LS48W5700LDMV40K	48"L x 5.75"W x 4.6"H / Acrylic Lens / 48W, 5700L / 0-10V Dim	CALL
HSL201A48LH72W8700LDMV40K	48"L x 5.75"W x 4.6"H / Acrylic Lens / 72W, 8700L / 0-10V Dim	CALL
HSL201A96LS48W5600LDMV40K	96"L x 5.75"W x 4.6"H / Acrylic Lens / 48W, 5600L / 0-10V Dim	CALL
HSL201A96LS65W8000LDMV40K	96"L x 5.75"W x 4.6"H / Acrylic Lens / 65W, 8000L / 0-10V Dim	CALL
HSL201A96LS97W11400LDMV40K	96"L x 5.75"W x 4.6"H / Acrylic Lens / 97W, 11400L / 0-10V Dim	CALL

Also available in 30K, 35K, 40K, 50K

**CORRIDOR LINEAR**



ITEM NO.	DESCRIPTION	SPECIAL PRICE
HSL1159A24LS24W1900LDMV40K	4.62"W x 24"L x 4.5"H	CALL
HSL159A24LS31W2300LDMV40K	4.62"W x 24"L x 4.5"H	CALL
HSL159A48LS48W3900LDMV40K	4.62"W x 48"L x 4.5"H	CALL
HSL159A48LS62W4700LDMV40K	4.62"W x 48"L x 4.5"H	CALL

**LED LINEAR WALL WASHER**

Fits neatly into a corner between ceiling and wall to provide general lighting or provides a surface mounted wall wash mounted one third of wall height from the wall.



ITEM NO.	DESCRIPTION	SPECIAL PRICE
HSLW4ASSF48LR24W2400LDMV40KWH	Linear Wall Washer 4"W x 48"L x 4"H, 0-10V Dimmable	CALL
HSLW4ASSF48LR48W4800LDMV40KWH	Linear Wall Washer 4"W x 48"L x 4"H, 0-10V Dimmable	CALL
HSLW4ASSF96LR48W4800LDMV40KWH	Linear Wall Washer 4"W x 96"L x 4"H, 0-10V Dimmable	CALL
HSLW4ASSF96LR96W9600LDMV40KWH	Linear Wall Washer 4"W x 96"L x 4"H, 0-10V Dimmable	CALL

Available in 3000K, 3500K and 5000K.

**VANDAL PROOF SURFACE MOUNT**

Ideal for Locker Rooms and Other High Traffic, Potentially Abusive Applications



ITEM NO.	DESCRIPTION	SPECIAL PRICE
HSLRSFR24LS25W2800LDMV40KWH	12"W x 24"L x 6"D 25 Watts, 2800 Lumens, 0-10V Dimmable Tamper Proof	CALL
HSLRSFR48LS50W5600LDMV40KWH	12"W x 48"L x 6"D 50 Watts, 5600 Lumens, 0-10V Dimmable Tamper Proof	CALL

Available with Clear Lens change FR to CL. For different color temperature change 40K to 30K, 35K, or 50K. For Emergency add EM for \$115.

## LED CONTINUOUS RUN LINEAR STRIP COVE LIGHTING (PLUG AND PLAY SYSTEM WITH CORD, PLUG AND BUTT CONNECTOR)



Adjustable and locking mounting bracket aims the light.

ITEM NO.	SIZE (W X L)	Watts / Lumens	Color Options (X100 Kelvins)	SPECIAL PRICE
HSLLCR48L18W2400LMV50K*	1" x 48"	18 / 2250	50	CALL
HSLLCR96L40W5200LMV50K*	1" x 96"	40 / 5000	50	CALL
HSLLCRADJMT**	Set of 3			CALL

\*\*Standard brackets included. Not dimmable. Check availability for other color temperatures.

## LINKABLE LED STRIP (EACH FIXTURE COMES WITH 3FT CORD & PLUG, MINI COUPLER AND MOUNTING CLIPS)



ITEM NO.	DESCRIPTION	SPECIAL PRICE
HSLLED13L4W360L50K	STRIP LED DED 4W 360 LUMENS 5000K	CALL
HSLLED22L7W630L50K	STRIP LED DED 7W 630 LUMENS 5000K	CALL
HSLLED23L8W720L50K	STRIP LED DED 8W 720 LUMENS 5000K	CALL
HSLLED35L14W1260L50K	STRIP LED DED 14W 1260 LUMENS 5000K	CALL
HSLLED47L18W1550L50K	STRIP LED DED 18W 1550 LUMENS 5000K	CALL
HSLLED12JOIN	STRIP LED DED 12in JOINER	CALL
HSLLED24JOIN	STRIP LED DED 24in JOINER	CALL
HSLLED6JOIN	STRIP LED DED 6in JOINER	CALL
HSLLEDJBOX	STRIP LED DED HARDWIRE JBOX	CALL

## LED STRIP WITH REFLECTOR (IDEAL FOR WALL WASHING)



Asymmetrical reflector provides wall wash (W35 Reflector)

ITEM NO.	DESCRIPTION	SPECIAL PRICE
HSLS24LR15W1600LW35DMV40K	24" STRIP ASYMMETRICAL REFLECTOR 15W 1600 LUMENS 4000K	CALL
HSLS48LR29W3200LW35DMV40K	48" STRIP ASYMMETRICAL REFLECTOR 29W 3200 LUMENS 4000K	CALL
HSLS60LR38W4070LW35DMV40K	60" STRIP ASYMMETRICAL REFLECTOR 38W 4070 LUMENS 4000K	CALL
HSLS96LR57W6400LW35DMV40K	96" STRIP ASYMMETRICAL REFLECTOR 57W 6400 LUMENS 4000K	CALL

Available in 3000K, 3500K, and 5000K. For continuous run, see wiring harness on page E10.



Shown W65 Reflector, ideal for coves.

Create perimeter lighting and brand image. Consult for custom fixtures and finishes.





Recessed Linear



SER Designer Strips



SESLinear



SSSWideBody



23 Series Recessed

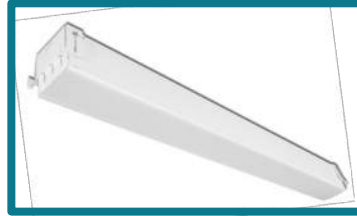

44 Series Recessed



66 Series



Linear Recessed Wall Wash

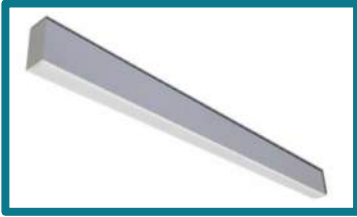

23 Series Pendant



SES Series Pendant



44 Series Pendant



66 Series Pendant



44 Square



44X Series



CLLL Series



LLL Series



LPLIN Series



SLP Series

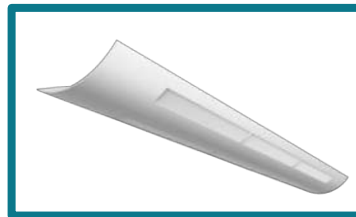

LIN Series



FHBL Series



FHBLFR Lensed



LVS Series



DID Series



LinearWallSeries Downlight



Linear Window



LVS Series



45 Degree Strip

**Note to our Valued Customers:**  
As the current climate of tariff policies continues to impact pricing, LITE can be a great resource to help minimize the impact on your purchases. Manufacturing domestically, we have the fixture advantage. We can also recommend or source alternative products that might be more cost effective. Please check with your sales consultant for options and current pricing.



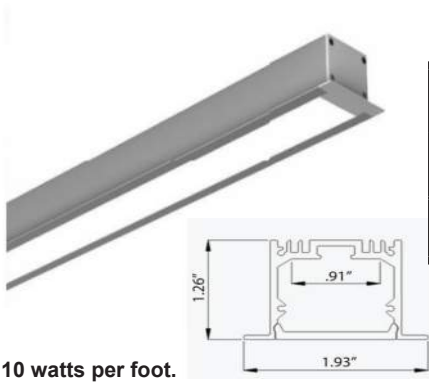

## RECESSED LINEAR 1.93" WIDTH w/FLANGE and REMOTE DRIVER

ITEM NO.	DESCRIPTION	SPECIAL PRICE
HSLLLLSR47L42W2488L30KSA	47" Square 1.93" SR Channel w/lens and 2 end caps and tape 30K installed with 10' clear wire	CALL
HSLLLLSR96L83W4976L30KSA	96" Square 1.93" SR Channel w/lens and 2 end caps and tape 30K installed with 10' clear wire	CALL

Change 30K to 40K for 4000 color temperature. Order driver separately.

**Ideal Choice for Customized Lengths. Available from Factory in Any Length at Value Pricing. Call for Pricing.**

## RECESSED LINEAR 2.16" w/FLANGE AND PATTERN ACCESSORIES

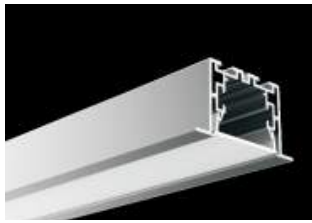

Consult for configuration and ordering.

ITEM NO.	DESCRIPTION	SPECIAL PRICE
HSLLLLFR48L24W2125L30KSA	47.24" Square Recessed 2.16"W x 1.38"H FR Channel w/lens and 2 end caps and tape 30K installed with 10' clear wire	CALL
HSLLLLFR48L24W2125L40KSA	47.24" Square Recessed 2.16"W x 1.38"H FR Channel w/lens and 2 end caps and tape 40K installed with 10' clear wire	CALL
HSLLLLFR96L49W4335L30KSA	96.46" Square Recessed 2.16"W x 1.38"H FR Channel w/lens and 2 end caps and tape 30K installed with 10' clear wire	CALL
HSLLLLFR96L49W4335L40KSA	96.46" Square Recessed 2.16"W x 1.38"H FR Channel w/lens and 2 end caps and tape 40K installed with 10' clear wire	CALL

Configure to any 5 watts per foot shape.

### LLLFR PATTERN OPTIONS

Configure recessed squares/rectangles or any pattern including up a wall and across a ceiling.

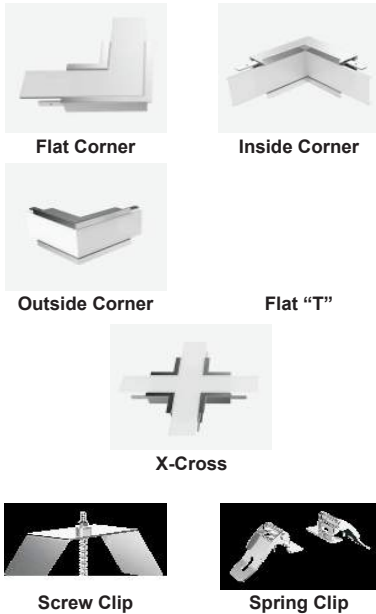

ITEM NO.	DESCRIPTION	SPECIAL PRICE
HSLLLLFRJOINER	Joiner Spline for LLL FR Extrusion	CALL
HSLLLLFRCORNER30K	LLLFR 90 DEGREE FLAT CORNER 3000K	CALL
HSLLLLFRCORNER40K	LLLFR 90 DEGREE FLAT CORNER 4000K	CALL
HSLLLLFRIS9030K	LLLFR 90 DEGREE INSIDE CORNER 3000K	CALL
HSLLLLFRIS9040K	LLLFR 90 DEGREE INSIDE CORNER 4000K	CALL
HSLLLLFRS9030K	LLLFR 90 DEGREE OUTSIDE CORNER 3000K	CALL
HSLLLLFRS9040K	LLLFR 90 DEGREE OUTSIDE CORNER 4000K	CALL
HSLLLLFRTEE30K	LLLFR FLAT "T" 3000K	CALL
HSLLLLFRTEE40K	LLLFR FLAT "T" 4000K	CALL
HSLLLLFRXCROSS30K	LLLFR FLAT X-CROSS 3000K	CALL
HSLLLLFRXCROSS40K	LLLFR FLAT X-CROSS 4000K	CALL
HSLLLLFRRECLIP	LLLFR RECESSED SCREW CLIP	CALL
HSLLLLFRSPRINGCLIP	LLLFR BUTTERFLY SPRING CLIP SET(2)	CALL

## REMOTE DRIVER (Dimmable with any standard MLV Triac (leading edge) control)



ITEM NO.	DESCRIPTION	Watts	SPECIAL PRICE
HSLMTIM60L24DC	Magnitude Magnetic Driver 60W 24VDC Encased	60	CALL
HSLMTIM100L24DC	Magnitude Magnetic Driver 96W 24VDC Encased	96	CALL
HSLMTIM150L24DC	Magnitude Magnetic Driver 150W 24VDC Encased	150	CALL

Consult for other drivers and wattages.

# LED Designer Strips

Ideal for All Applications

Dress up your linear strip with a “hot” color that will attract attention in your space. We can powder coat to any finish with an economical adder



Orange (OR)



Red (RD)



Matte White (WH)



Black (BK)

## LED CONTOURED STRIP

Wall or Ceiling mount, surface or pendant mounted, vertical or horizontal this fixture available standard in 3 sizes can be used individually or joined together for a continuous run. Standard in white but with a variety of finish options. Eight foot has one piece lens for a great look. See page E10 for continuous run wiring harness.

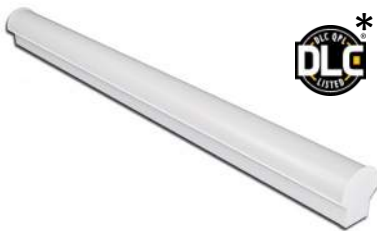

ITEM NO.	DESCRIPTION	SPECIAL PRICE
HLSERFR24LT14W1400LDMV40KWH	3.79"W x 23.60"L x 3.93"H / 14W, 1400L, 4000K	CALL
HLSERFR24LT20W2000LDMV40KWH	3.79"W x 23.60"L x 3.93"H / 20W, 2000L, 4000K	CALL
HLSERFR48LT28W3600LDMV40KWH*	3.79"W x 47.20"L x 3.93"H / 28W, 3600L, 4000K	CALL
HLSERFR48LT36W4500LDMV40KWH*	3.79"W x 47.20"L x 3.93"H / 36W, 4500L, 4000K	CALL
HLSERFR96LT56W7500LDMV40KWH*	3.79"W x 94.40"L x 3.93"H / 56W, 7500L, 4000K	CALL
HLSERFR96LT84W11000LDMV40KWH*	3.79"W x 94.40"L x 3.93"H / 84W, 11000L, 4000K	CALL

Check DLC listing for most current/additional Wattage and Lumen Options.

## with SENSOR

HLSSEFR24LT14W1400LDMV40KWH	3.79"W x 23.60"L x 3.93"H / 14W, 1400L, 4000K	CALL
HLSSEFR24LT20W2000LDMV40KWH	3.79"W x 23.60"L x 3.93"H / 20W, 2000L, 4000K	CALL
HLSSEFR48LT28W3600LDMV40KWH*	3.79"W x 47.20"L x 3.93"H / 28W, 3600L, 4000K	CALL
HLSSEFR48LT36W4500LDMV40KWH*	3.79"W x 47.20"L x 3.93"H / 36W, 4500L, 4000K	CALL
HLSSEFR96LT56W7500LDMV40KWH*	3.79"W x 94.40"L x 3.93"H / 56W, 7500L, 4000K	CALL
HLSSEFR96LT84W11000LDMV40KWH*	3.79"W x 94.40"L x 3.93"H / 84W, 11000L, 4000K	CALL

For Emergency, add EM and \$115.

See page E10 for hanging options or consult sales.





## LINEAR FIXTURE

ITEM NO.	DESCRIPTION	SPECIAL PRICE
HLSSESFR48LJ31W3100LDMV40KWH	2.36"W x 47.25"L x 2.83"H / 31W, 3100L, 4000K	CALL
HLSSESFR48LJ40W4000LDMV40KWH	2.36"W x 47.25"L x 2.83"H / 40W, 4000L, 4000K	CALL
HLSSESFR96LJ62W6200LDMV40KWH	2.36"W x 94.43"L x 2.83"H / 62W, 6200L, 4000K	CALL
HLSSESFR96LJ80W8000LDMV40KWH	2.36"W x 94.43"L x 2.83"H / 80W, 8000L, 4000K	CALL

Pendant mount available. Available in 3000K, 3500K, and 5000K. For Side Mount version with downlight change SES to SESW.



## LINEAR FIXTURE w/ SENSOR

(FIXTURE ON WHEN OCCUPIED, OFF WHEN NOT)



\$99 w/ Sensor

ITEM NO.	DESCRIPTION	SPECIAL PRICE
HLSSESFR24LJ20W2000LDMV40KWH	2.36"W x 23.6"L x 2.83"H / 20W, 2000L, 4000K	CALL
HLSSESFR48LJ31W3100LDMV40KWH	2.36"W x 47.25"L x 2.83"H / 31W, 3200L, 4000K	CALL
HLSSESFR96LJ62W6200LDMV40KWH	2.36"W x 94.43"L x 2.83"H / 62W, 6200L, 4000K	CALL
HLSSESFR24LH20W2000LSTMV40KWH	2.36" x 23.6", 20W 2000L with 50% Step Dim	CALL
HLSSESFR48LS31W3100LSTMV40KWH	2.36" x 47.3", 31W 3100L with 50% Step Dim	CALL
HLSSESFR96LS62W6200LSTMV40KWH	2.36" x 94.43", 62W 6200L with 50% Step Dim	CALL

Step Dim w/Sensor (Fixture ON when occupied, 50% when not). Consult for other finishes Pendant mount available. Available in 3000K, 3500K, and 5000K. Other Sensor Options See Page A3.



## LED LINEAR w/DAYLIGHT HARVESTING SENSOR



ITEM NO.	DESCRIPTION	SPECIAL PRICE
HLSDESFR24LH20W2000LDMV40KWH	2.36" x 23.6", 20W 2000L, Daylight Harvesting	CALL
HLSDESFR48LS31W3100LDMV40KWH	2.36" x 47.3", 31W 3100L, Daylight Harvesting	CALL
HLSDESFR96LS62W6200LDMV40KWH	2.36" x 94.43", 62W 6200L, Daylight Harvesting	CALL

SD - Daylight Harvesting Sensor in conjunction with 0-10V driver allow light level to adjust to ambient light. Available in 3000K, 3500K, and 5000K.



## WIDE BODY LINEAR STRIP w/SENSOR

(FIXTURE ON WHEN OCCUPIED, OFF WHEN NOT)

ITEM NO.	DESCRIPTION	SPECIAL PRICE
HLSSSKDWBFR24LZ35W3400LDMV40KWH	2 ft / 35W, 3400L / Color Temp 30, 35, 40, 50	CALL
HLSSSKDWBFR48LZ40W4000LDMV40KWH	4 ft / 40W, 4000L / Color Temp 30, 35, 40, 50	CALL
HLSSSKDWBFR48LZ72W7000LDMV40KWH	4 ft / 72W, 7000L / Color Temp 30, 35, 40, 50	CALL
HLSSSKDWBFR96LZ80W8000LDMV40KWH	8 ft / 80W, 8000L / Color Temp 30, 35, 40, 50	CALL
HLSSSKDWBFR96LZ114W10800LDMV40KWH	8 ft / 114W, 10800L / Color Temp 30, 35, 40, 50	CALL

Choose from three Recessed Mounting and Looks

Tbar Grid Ceiling  
Specify "R"

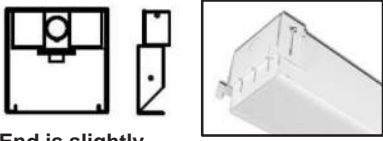

End is slightly shorter to accommodate the T Bar Grid.

Hard Ceiling -  
Sheetrock Flanged Version  
Specify "RF"

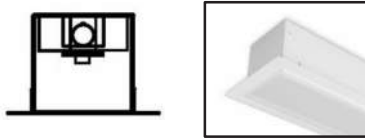

Hard Ceiling -  
Sheetrock Flangeless Version

Specify "RRXX" or "RRPF"  
XXX- Depth of Sheetrock  
RRPF - Perforated Flange to mud to

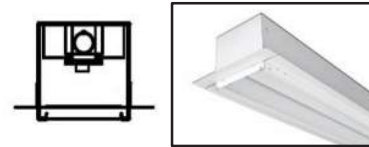

New Perforated Flange 1/4" below ceiling to mud to (RRPF)



RECESSED LINEAR 2" x 3"

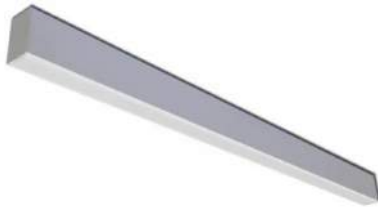

ITEM NO.	SIZE (W X L)	Watts / Lumens	Color Options (X100 Kelvins)	SPECIAL PRICE
HSSL23RSF48LT26W2600LDMV40KWH	2" x 47.32"	26 / 2600	30, 35, 40, 50	CALL
HSSL23RSF48LT38W3800LDMV40KWH	2" x 47.32"	38 / 3800	30, 35, 40, 50	CALL
HSSL23RSF48LT45W4500LDMV40KWH	2" x 47.32"	45 / 4500	30, 35, 40, 50	CALL
HSSL23RSF96LT52W5200LDMV40KWH	2" x 96"	52 / 5200	30, 35, 40, 50	CALL
HSSL23RSF96LT76W7600LDMV40KWH	2" x 96"	76 / 7600	30, 35, 40, 50	CALL
HSSL23RSF96LT90W9000LDMV40KWH	2" x 96"	90 / 9000	30, 35, 40, 50	CALL

23R - Recessed for T-Bar Grid, 23RF - Flanged, Add \$10 per 4 ft. 23RR(XXX) - Flangeless Hard Ceiling (xxx for sheetrock depth). Add \$10 per 4 ft. EM remote on 4 ft. See Specification sheet for flang option details. Remote only for emergency, add EM for \$115. For Dim to 1% up to 57watt, change DMV to D1MV and add \$10.00.

Recessed Linear 2.5" x 3"

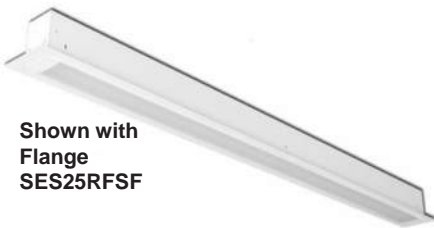

Shown with Flange  
SES25RFSF



For sensor, add SS in front and \$45.

ITEM NO.	SIZE (W X L)	Watts / Lumens	Color Options (X100 Kelvins)	SPECIAL PRICE
HLSSES25RSF48LT26W2600LDMV40KWH	2.5" x 47.32"	26 / 2600	30, 35, 40, 50	CALL
HLSSES25RSF48LT38W3800LDMV40KWH	2.5" x 47.32"	38 / 3800	30, 35, 40, 50	CALL
HLSSES25RSF48LT45W4500LDMV40KWH	2.5" x 47.32"	45 / 4500	30, 35, 40, 50	CALL
HLSSES25RSF96LT52W5200LDMV40KWH	2.5" x 96"	52 / 5200	30, 35, 40, 50	CALL
HLSSES25RSF96LT76W7600LDMV40KWH	2.5" x 96"	76 / 7600	30, 35, 40, 50	CALL
HLSSES25RSF96LT90W9000LDMV40KWH	2.5" x 96"	90 / 9000	30, 35, 40, 50	CALL

For Sensor Option add SS in front and \$45.00.

Dimming to 1%

Standard DMV provides dimming to 10% intensity. For Dim to 1% up to 57watt, change DMV to D1MV and add \$10.00.





Shown recessed fixture for Tbar / Grid ceiling.

## RECESSED LINEAR 4" x 4"

ITEM NO.	SIZE (W X L)	Watts / Lumens	Color Options (X100 Kelvins)	SPECIAL PRICE
HSL44RSF48LR24W2400LDMV40KWH	4" x 48"	24 / 2400	30, 35, 40, 50	CALL
HSL44RSF48LR48W4800LDMV40KWH	4" x 48"	48 / 4800	30, 35, 40, 50	CALL
HSL44RSF96LR48W4800LDMV40KWH	4" x 96"	48 / 4800	30, 35, 40, 50	CALL
HSL44RSF96LR96W9600LDMV40KWH	4" x 96"	96 / 9600	30, 35, 40, 50	CALL

44R - For T-Bar Grid Ceiling, 44RF - Flanged (Add \$10 per 4 ft.)  
 44RR(xxx) - Flangeless (Add \$10 per 4 ft.) Hard Ceiling (xxx for sheetrock depth)  
 See Specification sheet for flange option details.  
 For Sensor Option add SS in front and \$45.00.  
 For Dim to 1% up to 57watt, change DMV to D1MV and add \$10.00.



Shown "RF" recessed flange fixture

## RECESSED LINEAR 6" x 6"

ITEM NO.	SIZE (W X L)	Watts / Lumens	Color Options (X100 Kelvins)	SPECIAL PRICE
HSL66RSF48LR48W4800LDMV40KWH	6" x 48"	48 / 4800	30, 35, 40, 50	CALL
HSL66RSF96LR48W4800LDMV40KWH	6" x 96"	48 / 4800	30, 35, 40, 50	CALL
HSL66RSF96LR96W9600LDMV40KWH	6" x 96"	96 / 9600	30, 35, 40, 50	CALL

66R - For T-Bar Grid Ceiling, 66RF - Flanged and add \$10 per 4 ft.  
 66RR(xxx) - Flangeless Hard Ceiling (xxx for sheetrock depth) and add \$10 per 4 ft.  
 For Blade Louver change SF to BL and add \$15 per 4ft. To add with overlay add BLMW and \$20 per 4ft. For Regressed white Lens change SF to MW. For Sensor Option add SS in front and \$45.00. For Emergency, add EM for \$115.  
 For Dim to 1% up to 57watt, change DMV to D1MV and add \$10.00.

**Consult for 2FT and Other Custom Lengths**



Now Available with Snap Fit Lens (SF).  
 Shown without lens.  
 Available in 44 and 66 series.

## LINEAR RECESSED WALL WASH 4" x 4"

ITEM NO.	SIZE (W X L)	Watts / Lumens	Color Options (X100 Kelvins)	SPECIAL PRICE
HSL44RWSF48LRW24W2400LDMV40KWH	4" x 48"	24 / 2400	30, 35, 40, 50	CALL
HSL44RWSF48LRW48W4800LDMV40KWH	4" x 48"	48 / 4800	30, 35, 40, 50	CALL
HSL44RWSF96LRW48W4800LDMV40KWH	4" x 96"	48 / 4800	30, 35, 40, 50	CALL
HSL44RWSF96LRW96W9600LDMV40KWH	4" x 96"	96 / 9600	30, 35, 40, 50	CALL

For Sensor Option add SS in front and \$45.00. For Emergency, add EM for \$115. See specification sheet or above for the flange options.  
 For Dim to 1% up to 57watt, change DMV to D1MV and add \$10.00.

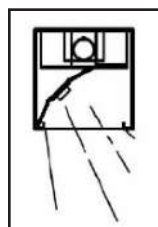

Specially designed reflector provides asymmetrical light distribution ideal for economical wall washing.

## LINEAR RECESSED WALL WASH 6" x 6"

ITEM NO.	SIZE (W X L)	Watts / Lumens	Color Options (X100 Kelvins)	SPECIAL PRICE
HSL66RWSF48LRW48W4800LDMV40KWH	6" x 48"	48 / 4800	30, 35, 40, 50	CALL
HSL66RWSF96LRW48W4800LDMV40KWH	6" x 96"	48 / 4800	30, 35, 40, 50	CALL
HSL66RWSF96LRW96W9600LDMV40KWH	6" x 96"	96 / 9600	30, 35, 40, 50	CALL

For Sensor Option add SS in front and \$45.00. For Emergency, add EM for \$115. See specification sheet or above for the flange options.  
 For Dim to 1% up to 57watt, change DMV to D1MV and add \$10.00.



Shown without lens.

# E7 SPECIALTY & ARCHITECTURAL LINEAR

Largest Selection of Linear LED Pendants from Less than 1 inch Wide to 8 inch Wide at Value Pricing.



Choose Your Finish

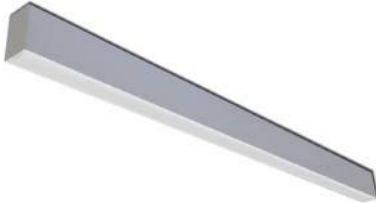

For continuous runs, see ordering on page E10.

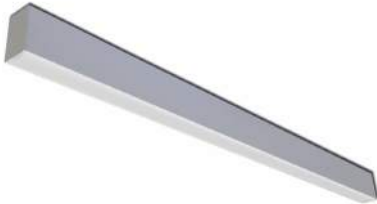

## LINEAR 2"X 3" PENDANT (UPLIGHT OR DOWNLIGHT ONLY)

ITEM NO.	SIZE (W X L)	Watts / Lumens	Color Options (X100 Kelvins)	SPECIAL PRICE
HSL23PSF48LR26W2600LDMV40KWH-HC301WH	2" x 48"	26 / 2600	30, 35, 40, 50	CALL
HSL23PSF48LR38W3800LDMV40KWH-HC301WH	2" x 48"	38 / 3800	30, 35, 40, 50	CALL
HSL23PSF48LR45W4500LDMV40KWH-HC301WH	2" x 48"	45 / 4500	30, 35, 40, 50	CALL
HSL23PSF96LR52W5200LDMV40KWH-HC301WH	2" x 96"	52 / 5200	30, 35, 40, 50	CALL
HSL23PSF96LR76W7600LDMV40KWH-HC301WH	2" x 96"	76 / 7600	30, 35, 40, 50	CALL
HSL23PSF96LR90W9000LDMV40KWH-HC301WH	2" x 96"	90 / 9000	30, 35, 40, 50	CALL

For Dimming, change "HC301WH" to "HC3015WWH" and add \$5.00.  
 For Surface Mounted, remove "HC301WH" and Deduct \$19.00.  
 For Emergency(External Battery Backup), add EM and \$199.00.  
 For Up Light, Add "U" after "L".  
 For Dim to 1% up to 57watt, change DMV to D1MV and add \$10.00

## LINEAR 2"X 3" PENDANT (UPLIGHT AND DOWNLIGHT)

ITEM NO.	SIZE (W X L)	Watts Up/Down	Color Options (X100 Kelvins)	SPECIAL PRICE
HSL23PSF48LUR12WD24WDMV40KWH-HC301WH	2" x 48"	12 / 24	30, 35, 40, 50	CALL
HSL23PSF48LUR18WD36WDMV40KWH-HC301WH	2" x 48"	18 / 36	30, 35, 40, 50	CALL
HSL23PSF96LUR24WD48WDMV40KWH-HC301WH	2" x 96"	24 / 48	30, 35, 40, 50	CALL
HSL23PSF96LUR36WD72WDMV40KWH-HC301WH	2" x 96"	36 / 72	30, 35, 40, 50	CALL

For Dimming, change "HC301WH" to "HC3015WWH" and add \$5.00.  
 For Surface Mounted, remove "HC301WH" and Deduct \$19.00.  
 For Emergency(External Battery Backup), add EM and \$199.00. For Dim to 1% up to 57watt, change DMV to D1MV and add \$10.00.

## LINEAR 2.5" X 3.5" PENDANT (DOWNLIGHT ONLY)

ITEM NO.	SIZE (W X L)	Watts / Lumens	Color Options (X100 Kelvins)	SPECIAL PRICE
HLSSES25PSF48LR26W2600LDMV40KWH-HC301WH	2.5" x 48"	26 / 2600	30, 35, 40, 50	CALL
HLSSES25PSF48LR38W3800LDMV40KWH-HC301WH	2.5" x 48"	38 / 3800	30, 35, 40, 50	CALL
HLSSES25PSF48LR45W4500LDMV40KWH-HC301WH	2.5" x 48"	45 / 4500	30, 35, 40, 50	CALL
HLSSES25PSF96LR52W5200LDMV40KWH-HC301WH	2.5" x 96"	52 / 5200	30, 35, 40, 50	CALL
HLSSES25PSF96LR76W7600LDMV40KWH-HC301WH	2.5" x 96"	76 / 7600	30, 35, 40, 50	CALL
HLSSES25PSF96LR90W9000LDMV40KWH-HC301WH	2.5" x 96"	90 / 9000	30, 35, 40, 50	CALL

For Dimming, change "HC301WH" to "HC3015WWH" and add \$5.00.  
 For Surface Mounted, remove "HC301WH" and Deduct \$19.00.  
 For Emergency(External Battery Backup), add EM and \$199.00.



## LINEAR 4" X 4" PENDANT (DOWNLIGHT ONLY)

ITEM NO.	SIZE (W X L)	Watts / Lumens	Color Options (X100 Kelvins)	SPECIAL PRICE
HSL44PSF48LR24W2400LDMV40KWH-HC301WH	4" x 48"	24 / 2400	30, 35, 40, 50	CALL
HSL44PSF48LR48W4800LDMV40KWH-HC301WH	4" x 48"	48 / 4800	30, 35, 40, 50	CALL
HSL44PSF96LR48W4800LDMV40KWH-HC301WH	4" x 96"	48 / 4800	30, 35, 40, 50	CALL
HSL44PSF96LR96W9600LDMV40KWH-HC301WH	4" x 96"	96 / 9600	30, 35, 40, 50	CALL

For surface mount remove HC301WH and deduct \$19. For emergency, add EM and \$115. For Dimming add "5W" after HC301 and add \$5.00. For Dim to 1% up to 57watt, change DMV to D1MV and add \$10.00. For Indirect only options add U after the length and L.

Ex: 44PSF48LR26W - becomes 44PSF48LR26W

## SENSOR READY LINEAR 4" X 4" (DOWNLIGHT ONLY)

ITEM NO.	SIZE (W X L)	Watts / Lumens	Color Options (X100 Kelvins)	SPECIAL PRICE
HSLSS44PSF48LR24W2400LDMV40KWH-HC301WH	4" x 48"	24 / 2400	30, 35, 40, 50	CALL
HSLSS44PSF48LR48W4800LDMV40KWH-HC301WH	4" x 48"	48 / 4800	30, 35, 40, 50	CALL
HSLSS44PSF96LR48W4800LDMV40KWH-HC301WH	4" x 96"	48 / 4800	30, 35, 40, 50	CALL
HSLSS44PSF96LR96W9600LDMV40KWH-HC301WH	4" x 96"	96 / 9600	30, 35, 40, 50	CALL

SS comes standard with Occupancy Sensor. For Daylight Harvesting change SS to SD and add \$25. For Dimming add "5W" after HC301 and add \$5.00.

## LINEAR 4" X 5" (UPLIGHT AND DOWNLIGHT)

ITEM NO.	SIZE (W X L)	Watts Up / Down	Color Options (X100 Kelvins)	SPECIAL PRICE
HSL45PSF48LUR12WD24WDMV40KWH-HC301WH	4" x 48"	12 / 24	30, 35, 40, 50	CALL
HSL45PSF48LUR18WD36WDMV40KWH-HC301WH	4" x 48"	18 / 36	30, 35, 40, 50	CALL
HSL45PSF96LUR24WD48WDMV40KWH-HC301WH	4" x 96"	24 / 48	30, 35, 40, 50	CALL
HSL45PSF96LUR36WD72WDMV40KWH-HC301WH	4" x 96"	36 / 72	30, 35, 40, 50	CALL

For surface mount remove HC301WH and deduct \$19. For Emergency, add EM and \$115. For Dimming add "5W" after HC301 and add \$5.00. For Dim to 1% up to 57watt, change DMV to D1MV and add \$10.00.

## LINEAR 6" X 6" PENDANT (UPLIGHT OR DOWNLIGHT ONLY)

ITEM NO.	DESCRIPTION	SPECIAL PRICE
HSL66PSF48LR24W2400LDMV40KWHHC401WH	6.00" X 6.00" X 48" / 24W, 2400L, 4000K	CALL
HSL66PSF48LR48W4800LDMV40KWHHC401WH	6.00" X 6.00" X 48" / 48W, 4800L, 4000K	CALL
HSL66PSF96LR48W4800LDMV40KWHHC401WH	6.00" X 6.00" X 96" / 48W, 4800L, 4000K	CALL
HSL66PSF96LR97W9600LDMV40KWHHC401WH	6.00" X 6.00" X 96" / 97W, 9600L, 4000K	CALL

For Emergency, add EM and \$115. For Dimming add "5W" after HC401 and add \$5.00.

Now Available with Snap Fit lens specially designed for LED Arrays. Change MW to SF for Snap Fit Lens. For Up Light, Add "U" after "L". For Dim to 1% up to 57watt, change DMV to D1MV and add \$10.00.

## LINEAR 6" X 6" PENDANT (UPLIGHT AND DOWNLIGHT)

ITEM NO.	DESCRIPTION	Watts Up / Down	Color Options (X100 Kelvins)	SPECIAL PRICE
HSL66PSF48LUR12WD24WDMV40KWHHC401WH	6.00" X 6.00" X 48"	12 / 24	30, 35, 40, 50	CALL
HSL66PSF48LUR24WD48WDMV40KWHHC401WH	6.00" X 6.00" X 48"	24 / 48	30, 35, 40, 50	CALL
HSL66PSF96LUR24WD48WDMV40KWHHC401WH	6.00" X 6.00" X 96"	24 / 48	30, 35, 40, 50	CALL
HSL66PSF96LUR36WD72WDMV40KWHHC401WH	6.00" X 6.00" X 96"	36 / 72	30, 35, 40, 50	CALL

Wall washer option -Add \$25 for 4 ft. \$50 for 8 ft. for asymmetrical reflector.

Now Available with Snap Fit lens specially designed for LED Arrays. Change SF to MW for Matte White Lens. For Dim to 1% up to 57watt, change DMV to D1MV and add \$10.00.



For continuous runs, see ordering on page E10.



Consult for 2ft and custom sizes.



For continuous runs, see ordering on page E10.



For matching wall version, see page F3.

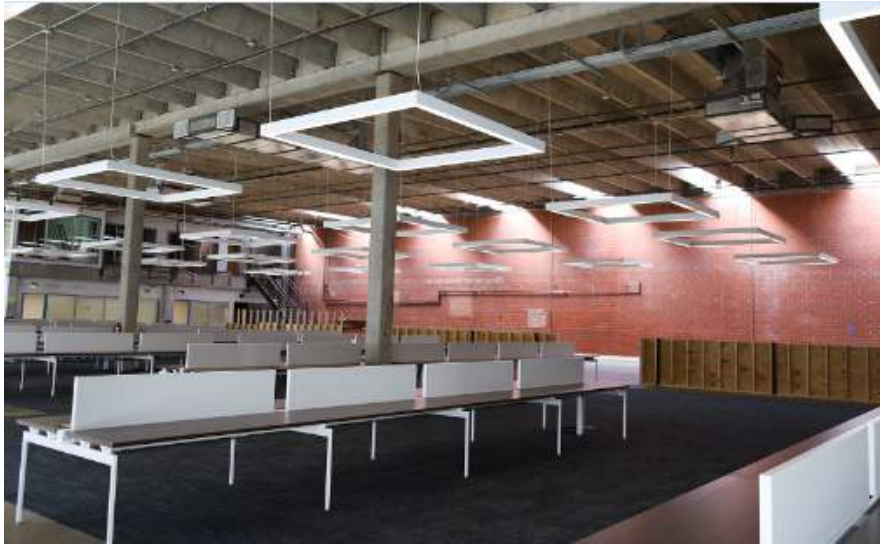

Linear configurations with lit or unlit corner options provide a dramatic look and lighting effect that completely change the aesthetics of the space. If you can dream it, we can make it.

### 4X4 SQUARE IN 4FT SQ AND 8FT SQ (DOWNLIGHT) 6 OR 8 WATTS PER FOOT



Lit corners

**Consult for Different Configurations (Squares or Rectangles, Up and Downlight Versions, or Different Shapes of Lit Patterns)**

ITEM NO.	DESCRIPTION	SPECIAL PRICE
HSL44PSF4X4R96WDMV40KWHHC401WH	4x4" 4ft. Sq / 96W, 9600L / White 3 Wire Cord	CALL
HSL44PSF4X4R96WDMV40KWHHC4015WWH	4x4" 4ft. Sq / 96W, 9600L / White 5 Wire Cord for 0-10V Dim	CALL
HSL44PSF4X4R128WDMV40KWHHC401WH	4x4" 4ft. Sq / 128W, 12800L / White 3 Wire Cord	CALL
HSL44PSF4X4R128WDMV40KWHHC4015WWH	4x4" 4ft. Sq / 128W, 12800L / White 5 Wire Cord for 0-10V Dim	CALL
HSL44PSF8X8R192WDMV40KWHHC401WH	4x4" 8ft. Sq / 192W, 19200L / White 3 Wire Cord	CALL
HSL44PSF8X8R192WDMV40KWHHC4015WH	4x4" 8ft. Sq / 192W, 19200L / White 5 Wire Cord for 0-10V Dim	CALL
HSL44PSF8X8R256WDMV40KWHHC401WH	4x4" 8ft. Sq / 256W, 25600L / White 3 Wire Cord	CALL
HSL44PSF8X8R256WDMV40KWHHC4015WWH	4x4" 8ft. Sq / 256W, 25600L / White 5 Wire Cord for 0-10V Dim	CALL

For Emergency, add EM and \$115. Consult for up and downlight. Available in 3000k, 3500K and 5000K. For Dim to 1% up to 57watt, change DMV to D1MV and add \$10.00.

### LINEAR 4"X 4" PENDANT (DOWNLIGHT ONLY) UNLIT CORNERS



**For continuous runs, see ordering on page E10.**



Joiner Box

ITEM NO.	SIZE (W X L)	Watts / Lumens	Color Options (X100 Kelvins)	SPECIAL PRICE
HSL44PSF48LR24W2400LDMVPI3D40KWH-HC301WH	4" x 48"	24 / 2400	30, 35, 40, 50	CALL
HSL44PSF48LR48W4800LDMVPI3D40KWH-HC301WH	4" x 48"	48 / 4800	30, 35, 40, 50	CALL
HSL44PSF96LR48W4800LDMVPI3D40KWH-HC301WH	4" x 96"	48 / 4800	30, 35, 40, 50	CALL
HSL44PSF96LR96W9600LDMVPI3D40KWH-HC301WH	4" x 96"	96 / 9600	30, 35, 40, 50	CALL
HSL44JB1WAYWH	Straight Joiner			CALL
HSL44JB2WAYWH	90 Degree Joiner			CALL
HSL44JB3WAYWH	T Connector (3 Way)			CALL
HSL44JB4WAYWH	X Connector (4 Way)			CALL
HSL44E10WAYWH	End of Run			CALL

For surface mount remove HC301WH and deduct \$19. For emergency, add EM and \$115. For Dimming add "5W" after HC301 and add \$5.00. For Dim to 1% up to 57watt, change DMV to D1MV and add \$10.00. PATTERNS W/NON LIT CORNERS - Choose Straight Run 44 Series Pendants and Then Choose Appropriate Non Lit Corner Accessory (Consult Light for 45 Series Up and Down Option or other Sizes)





Shown custom finish

## 4" X 4" LINEAR X SERIES

ITEM NO.	DESCRIPTION	SPECIAL PRICE
HSLX44PSF2X2R48WDMV40KWHHC4015WWH	4" X 4" 2 FT CROSS DIMMABLE, 48W Total and 12W Per 2ft Run, 4800 Lumens, White 5 Wire Cord for 0-10V Dim	CALL
HSLX44PSF4X4R96WDMV40KWHHC4015WWH	4" X 4" 4 FT CROSS DIMMABLE, 96W Total and 24W Per 4ft Run, 9600 Lumens, White 5 Wire Cord for 0-10V Dim	CALL

Consult for Different shapes, sizes or finishes

### Ordering Patterns

**You can draw it, we can make it!**

LITE Technology can create patterns with 23, 44, 45 and 66 Series. Patterns are available for recessed and pendant mounting versions with lit corners or unlit corners. See below for some of the possibilities and consult factories for exact ordering numbers and pricing.



Engineered ends either accept end cap to complete run or to join two fixtures together for continuous runs.

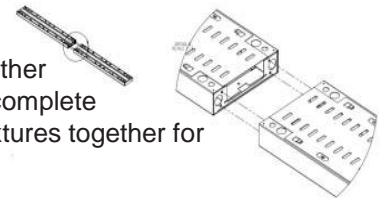

### Continuous Run Ordering for 23, 44, 45, 66, LPLIN and SLP Series

1. Determine the run length and whether the run will be dimmed or not.
2. Use the above 2, 4 or 8 ft. runs from the Series Specified to add up to total run length. Use the largest individual fixtures to achieve run lengths (i.e. for 20 ft. run use 2x8 ft. individuals and 1x4 ft. individual from above with the correct ordering info for your series). Watts and lumens for each section should be proportional for the size (i.e. If 48W with 4 ft then 8 ft should be 96W). Consult for other lengths.
3. Designate each length required in the run whether it will be the **beginning of the run "B", joiner in the run "J" or the end "E" of the run. Add the letter designation to the end of the part number.**
4. For Plug and Play electrical wiring between individual fixtures in the run, add one of the following harnesses. The number of wires is based on whether the run will be dimmable, with emergency or just ON/OFF.

#### Add Wiring Harness Code After the Driver Designation

PI1 - 3 Wire Harness (normally for non-dim applications) **\$9.95**

PI2 - 4 Wire Harness (normally for emergency circuit) **\$10.95**

PI3D - 5 Wire Harness (normally for 0-10V dimming) **\$11.95**

PI4D - 6 Wire Harness (normally for 0-10V dimming and emergency) **\$13.95**



For continuous runs, first remove the end plates on the fixtures you want to join together; then using bolts and nuts (4X), attach the two ends together. Be sure both fixtures are properly aligned before tightening the bolts. Repeat steps for the overall length desired. Finish run, with the end plate attached to the last fixture in the run.

### Linear Fixture Cable Hanging Options:

ITEM NO.	DESCRIPTION	SPECIAL PRICE
HSLHC301WH	4ft Cable and Power feed Linear Fixtures	CALL
HSLHC302WH	12ft Cable and Power feed Linear Fixtures	CALL

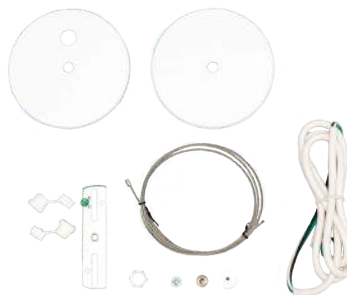

# All-In-One LED Channels

4x8 Foot Rectangle Provides Dramatic Look  
 Installs in under 30 minutes with user friendly electrical and mechanical joiners.  
 Lowest Price Per Foot!



## 4X8 RECTANGLE



ITEM NO.	DESCRIPTION	SPECIAL PRICE
HSLCLLLSF4X8T210WDMV35KALHC705WH	Aluminum - 2.2"Wx2.8"HT x 8', 210W, 21000L 3500K	CALL
HSLCLLLSF4X8T210WDMV35KWHHC705WH	White - 2.2"Wx2.8"HT x 8', 210W, 21000L 3500K	CALL

Change 35K to 40K for 4000K Color Temperature.  
 Preconfigured Rectangle with 2.2 Inch Wide Channel in Choice of White or Satin Aluminum Finish.  
 Pendant Cable Kit comes standard for 6ft. drop. For up to 12ft. drop order LLLSF4X8HC6125WWH \$69.00

## Individual or Continuous Use ~ Convenient and Simple to Install



Based on your feedback, our brand new All-In-One LED Linear Channels are now improved and easier than ever to: specify, order and install! This integral driver channel in two different profiles is great for an individual fixture (in 4 or 8 foot), and to join multiple channels for longer, continuous runs (in 4 or 8 foot multiples). This beautifully finished aluminum channel can be easily installed by any professional in just minutes. Even a "do-it-yourselfer" will appreciate that this fixture comes with step by step instructions. A specially designed integral wiring harness (ordered separately) makes joining two channels electronically simple and efficient. A unique, mechanical joiner bracket in conjunction with our special joiner tool allows for joining two or more channels together with no light leak and a clean connection.

**LLLSF\***  
 2.16" Wide, 2.75" Tall

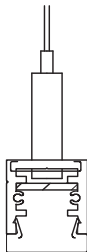

**LLLSG\***  
 3.54" Wide, 3.38" Tall

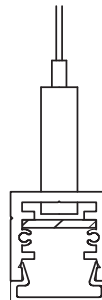

**Custom Finishes Available**  
**2 Sizes Ready to Ship!**

\* Available for Pendant Mounting & Surface Mounting applications

Order one item number for complete luminaires!



**Ready to Ship!**  
*(Within 48 Hours)*

LLLSF - 2.16" wide  
OR  
LLLSG - 3.54" wide



*Three-part system allows for easy wiring with prewired harnesses and allows for custom finishes on channel (Consult)*

**FEATURES INCLUDE:**

- Aluminum Channel
- Integral Driver
- Snap Fit Lens
- Magnetic Light Leak Block
- Integral Wire Harness



*Joins easily with a mechanical spline*

Width	Length	Pendant Mounted		Description	Surface Mounted	
		Preconfigured Kit Part Number	Special Pricing		Preconfigured Kit Part Number	Special Pricing
LLLSF	4'	HSLCLLSF48L31WCDMV30KSAHC605WH	\$155.00	48"L x 2.2"W x 2.8"H / 31W 3100	HSLCLLSF48L31WCDMV30KSASURF	\$145.00
	8'	HSLCLLSF96L62WCDMV30KSAHC605WH	\$228.00	96"L x 2.2"W x 2.8"H / 62W 6200L	HSLCLLSF96L62WCDMV30KSASURF	\$218.00
	12'	HSLCLLSF144L93WCDMV30KSAHC605WH	\$381.00	144"L x 2.2"W x 2.8"H / 93W 9300L	HSLCLLSF144L93WCDMV30KSASURF	\$368.00
	16'	HSLCLLSF192L124WCDMV30KSAHC605WH	\$454.00	192"L x 2.2"W x 2.8"H / 124W 12400	HSLCLLSF192L124WCDMV30KSASURF	\$441.00
LLLSG	4'	HSLCLLSG48L45WCDMV30KSAHC605WH	\$197.00	48"L x 3.5"W x 2.8"H / 45W 5000L	HSLCLLSG48L45WCDMV30KSASURF	\$187.00
	8'	HSLCLLSG96L90WCDMV30KSAHC605WH	\$296.00	96"L x 3.5"W x 2.8"H / 90W 1000L	HSLCLLSG96L90WCDMV30KSASURF	\$285.00
	12'	HSLCLLSG144L135WCDMV30KSAHC605WH	\$485.00	144"L x 3.5"W x 2.8"H / 135W 13500	HSLCLLSG144L135WCDMV30KSASURF	\$478.00
	16'	HSLCLLSG192L180WCDMV30KSAHC605WH	\$584.00	192"L x 3.5"W x 2.8"H / 180W 18000	HSLCLLSG192L180WCDMV30KSASURF	\$577.00

**For custom finishes Red, Blue, Satin Nickel, Satin Brass, Black and others, consult sales rep for pricing.**

*\*\*All hanging kits come with a White Canopy. Standard hanging kit length is 72", For 144" hanging kit, please replace "HC605WH" with "HC612WH" and add \$5.00.  
(Ex. CLLSF-48L30W-DMV-30K-SA-HC612WH).\*\**

*Nomenclature shown reflects 3000K Color Temperature.  
Change "30K" to "40K" for 4000K Color Temperature\**



Silver (SL)



Red (RD)



Black (BK)



Bronze (BZ)



**LLLSFLENSTOOL**

Tool Required to Remove Lens and  
Tool Required to Remove Harness  
(1 per Installation needed)  
\$7.00



**LLLSGJOINERTOOL**

Tool Required to Use Mechanical  
Joiner (1 per Installation of Continuous  
Runs)\$3.00



## LED LINEAR CHANNEL IN 2 SIZES w/ INTEGRAL DRIVER

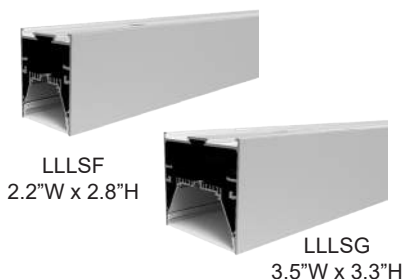

ITEM NO.	DESCRIPTION	SPECIAL PRICE
<b>HSLLLLSF - Alum. Channel 2.2\"W x (48\"L or 96\"L) x 2.8\"H</b>		
HSLLLLSF48L31W3100LDMV40KSA	31W 3100L, 4000K 0-10V Dimming Multi-Volt	CALL
HSLLLLSF96L62W6200LDMV40KSA	62W 6200L, 4000K 0-10V Dimming Multi-Volt	CALL
<b>HSLLLLSG - Alum. Channel 3.5\"W x (48\"L or 96\"L) x 3.3\"H</b>		
HSLLLLSG48L48W5040LDMV40KSA	48W 5040L, 4000K 0-10V Dimming Multi-Volt	CALL
HSLLLLSG96L96W10080LDMV40KSA	96W 10080L, 4000K 0-10V Dimming Multi-Volt	CALL

Change 40K to 30K for 3000K

**Consult for Finish Options.**

## JOIN TWO OR MORE CHANNELS TOGETHER

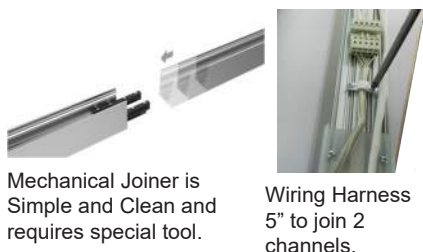

Mechanical Joiner is Simple and Clean and requires special tool.

Wiring Harness 5\" to join 2 channels.

ITEM NO.	DESCRIPTION	SPECIAL PRICE
HSLLLLSFJOINER	Mechanical Joiner to Join 2 LLLSF Channels	CALL
HSLLLLSGJOINER	Mechanical Joiner to Join 2 LLLSG Channels	CALL
HSLLLLSGJOINERTOOL	Tool Required to Use Mechanical Joiner (1 per Installation)	CALL
HSLLLLSFLENSTOOL	Tool Required to Remove Lens; 1 per installation needed	CALL
HSLLLLSF5WMFH*	Wiring Harness 5\" to Join 2 Channels	CALL

\*Included with Channels only need to purchase for replacements

## 3 MOUNTING OPTIONS (SURFACE, PENDANT AND RECESSED)

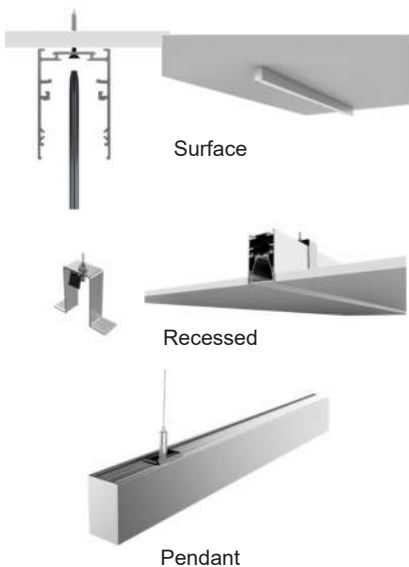

ITEM NO.	DESCRIPTION	SPECIAL PRICE
HSLLLLSFSURFKIT	Surface Mount Screw and Toggle Set of 3 (Includes 24 inch power cord)	CALL
HSLLLLSFRECKIT*	Recessed Mounting Brackets for LLLSF (Set of 2) (Includes 24 inch power cord)	CALL
HSLLLLSGRECKIT*	Recessed Mounting Brackets for LLLSG (Set of 2) (Includes 24 inch power cord)	CALL
HSLLLLSFHCPF605WWH**	Pendant Mounting Power Feed Canopy Kit 5 Wire for up to 6FT Drop	CALL
HSLLLLSFHCPF6125WWH**	Pendant Mounting Power Feed Canopy Kit 5 Wire for up to 12FT Drop	CALL
HSLLLLSFHCPNF605WWH	Pendant Mounting Non-Power Canopy Kit, 6 FT Cable with Canopy	CALL
HSLLLLSFHCPNF612WWH	Pendant Mounting Non-Power Canopy Kit, 12 FT Cable with Canopy	CALL

\* Aluminum Channel has no flang so review Recessed Application to ensure this will work.

\*\*Use One Power Feed Canopy Kit every place mounting to Power. Non Power Feed Version Order Separately for Mounting where No Power Feed is Required.



## LED LINEAR PENDANT (1.57" Wide and 6 Watts Per FT)



1.57" Wide x 2.54" Height Satin Aluminum. Requires Remote Driver.

ITEM NO.	DESCRIPTION	SPECIAL PRICE
HSLLLLSH48L24W2125L30KSA	47.24" Square Pendant 1.57"W x 2.54"H SH Channel w/lens and 2 end caps and tape 30K installed with 10' clear wire	CALL
HSLLLLSH48L24W2125L40KSA	47.24" Square Pendant 1.57"W x 2.54"H SH Channel w/lens and 2 end caps and tape 40K installed with 10' clear wire	CALL
HSLLLLSH96L49W4335L30KSA	96.46" Square Pendant 1.57"W x 2.54"H SH Channel w/lens and 2 end caps and tape 30K installed with 10' clear wire	CALL
HSLLLLSH96L49W4335L40KSA	96.46" Square Pendant 1.57"W x 2.54"H SH Channel w/lens and 2 end caps and tape 40K installed with 10' clear wire	CALL

Order driver and accessories separately.

**Available in custom sizes and patterns. We make it easy!**

## LLLSH PATTERNS OPTIONS

ITEM NO.	DESCRIPTION	SPECIAL PRICE
HSLLLLSHCAP	END CAP	CALL
HSLLLLSHLOCKER	Internal Locker for GEAR TRAY	CALL
HSLLLLSHRECClip	RECESSED SCREW CLIP	CALL
HSLLLLSHWALLCLIP	WALL MOUNT ELL CLIP	CALL
HSLLLLSHJOINER	Joiner Spline for LLL SH Extrusion	CALL
HSLLLLSHCORNER30K	90° FLAT CORNER 3000K	CALL
HSLLLLSHCORNER40K	90° FLAT CORNER 4000K	CALL
HSLLLLSHTEE30K	FLAT "T" 3000K	CALL
HSLLLLSHTEE40K	FLAT "T" 4000K	CALL
HSLLLLSHCROSS30K	FLAT X-CROSS 3000K	CALL
HSLLLLSHCROSS40K	FLAT X-CROSS 4000K	CALL
HSLLLLSHHC601WH	LLLSH Pendant parts kit 2M	CALL
HSLLLLSHHC602WH	LLLSH Pendant parts kit 4M	CALL



End Cap

Internal Locker

Screw Clip

Ell Clip

Flat Corner

Flat "T"

X-Cross

Pendant Kit

HC601 Cable Kit

HC601 Canopy

## REMOTE DRIVER (Dimmable with any standard MLV Triac (leading edge) control)



ITEM NO.	DESCRIPTION	Watts	SPECIAL PRICE
HSLMTIM60L24DC	Magnitude Magnetic Driver 60W 24VDC Encased	60	CALL
HSLMTIM100L24DC	Magnitude Magnetic Driver 96W 24VDC Encased	96	CALL
HSLMTIM150L24DC	Magnitude Magnetic Driver 150W 24VDC Encased	150	CALL

Consult for other drivers and wattages.

**LED Linear Channels w/ Remote Drivers (LLL Series)**

**LLLRA 1.5" Diameter, 3 watts per ft**



ITEM NO.	DESCRIPTION	WATTS	SPECIAL PRICE
HSLLLLRA48L35W2246L30KSA	47.75" Round 1.6" Dia. RA Channel w/Lens and 2 End Caps and Tape 30K Installed with 10' Clear Wire	35	CALL
HSLLLLRA97L69W4492L30KSA	92" Round 1.6" Dia. RA Channel w/Lens and 2 End Caps and Tape 30K Installed with 10' Clear Wire	69	CALL

Not available for surface mount. See accessories below.

**LLLRB 2.4" Diameter, 4 watts per ft**

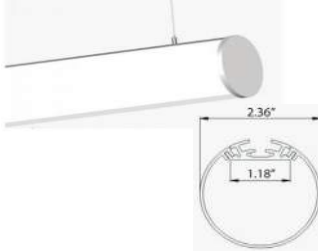

HSLLLLRB47L42W2488L30KSA	47.75" Round 2.36" Dia. RB Extrusion w/Lens and 2 End Caps and Tape 30K Installed with 10' Clear Wire	42	CALL
HSLLLLRB99L96W4976L30KSA	96" Round 2.36" Dia. RB Extrusion w/Lens and 2 End Caps and Tape 30K Installed with 10' Clear Wire	83	CALL

See accessories below.

**LLLSA 0.78" Diameter, 2 watts per ft**

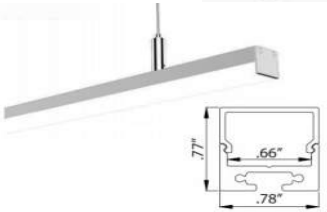

HSLLLLSA48L23W1500L30KSA	47.75" Square 0.77" SA Channel w/Lens and 2 End Caps and Tape 30K Installed with 10' Clear Wire	23	CALL
HSLLLLSA97L46W3000L30KSA	97" Square 0.77" SA Channel w/Lens and 2 End Caps and Tape 30K Installed with 10' Clear Wire	46	CALL

See accessories below.

**LLLSB 1.4" Diameter, 4 watts per ft**

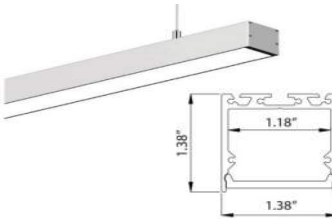

HSLLLLSB47L42W2488L30KSA	47" Square 1.38" SB Channel w/Lens and 2 End Caps and Tape 30K Installed with 10' Clear Wire	42	CALL
HSLLLLSB96L83W4976L30KSA	96" Square 1.38" SB Channel w/Lens and 2 End Caps and Tape 30K Installed with 10' Clear Wire	83	CALL

See accessories below.

**LLLSC 1.9" Diameter, 5 watts per ft**



HSLLLLSC48L58W3456L30KSA	47.75" Rect. 1.92W" x 2.75H" SC Extrusion w/Lens and 2 End Caps and Tape 30K Installed with 10' Clear Wire	58	CALL
HSLLLLSC97L115W6912L30KSA	97" Rect. 1.92W" x 2.75H" SC Extrusion w/Lens and 2 End Caps and Tape 30K Installed with 10' Clear Wire	115	CALL

See accessories below.

**Drivers and Accessories**

**Consult for Custom Finish.**

ITEM NO.	DESCRIPTION	SPECIAL PRICE
HSLMTIM40L24DC	Magniture Magnetic Driver 40W 24VDC Encased	CALL
HSLMTIM60L24DC	Magniture Magnetic Driver 60W 24VDC Encased	CALL
HSLMTIM100L24DC	Magniture Magnetic Driver 96W 24VDC Encased	CALL
HSLMTIM150L24DC	Magniture Magnetic Driver 150W 24VDC Encased	CALL
<b>Cable Kits</b>		
HSLHC601WH	Cable kit with 6' cable and power feed/cable incl. and white canopy	CALL
HSLHC602WH	Cable kit with 12' cable and power feed/cable incl. and white canopy	CALL
<b>Joiners</b>		
HSLLLLRAJOIN	Mechanical joiner spline for RA and SC	CALL
HSLLLLSAJJOIN	Mechanical joiner spline for RB, SA and SB	CALL



Consult for accessories to make patterns

Change 30K to 40K for 4000 color temperature. Consult for surface mount to order channel and tape separately.

## BULLNOSE STYLE WITH DIRECT/INDIRECT LIGHTING



For continuous runs, see ordering on page E10.



ITEM NO.	SIZE	Watts	Color Temp	SPECIAL PRICE
HSLPLINFR48LUF12WD24WDMV40KWH*-HC401WH*	48"	12W Up 24W Down	30, 35, 40, 50	CALL
HSLPLINFR48LUF30WD60WDMV40KWH*-HC401WH*	48"	130 Up 60W Down	30, 35, 40, 50	CALL
HSLPLINFR96LUF24WD48WDMV40KWH*-HC401WH*	96"	24W Up 48W Down	30, 35, 40, 50	CALL
HSLPLINFR96LUF60WD120WDMV40KWH*-HC401WH*	96"	60W Up 120W Down	30, 35, 40, 50	CALL

For 0-10 Dimming. Change 401WH to 4015WWH and add \$5.00. For Emergency, add EM and \$115. Consult for other Direct/Indirect Options.

\*Check DLC listing for most current/additional Wattage and Lumen Options.

Ideal for Direct/Indirect Applications

## LINEAR WINDOW LED WITH DIRECT/INDIRECT LIGHTING

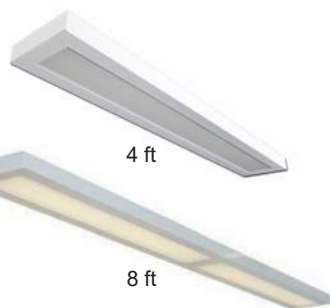

For continuous runs, see ordering on page E10.

For Wall version see page F2.

ITEM NO.	SIZE	Watts	Color Temp	SPECIAL PRICE
<b>Downlight</b>				
HSLSLPFR48LS48W5400LDMV40KWH-HC401WH	7.6" x 48"	48W, 5400L, All downlight, Color Temp 30, 35, 40, 45		CALL
HSLSLPFR96LS96W10800LDMV40KWH-HC401WH	7.6" x 96"	96W, 10800L, All downlight, Color Temp 30, 35, 40, 45		CALL
<b>Up and Downlight</b>				
HSLSLPFR48LUS12WD24WDMV40KWH-HC401WH	48"	12W Up 24W Down	30, 35, 40, 50	CALL
HSLSLPFR48LUS18WD36WDMV40KWH-HC401WH	48"	18W Up 36W Down	30, 35, 40, 50	CALL
HSLSLPFR96LUS24WD48WDMV40KWH-HC401WH	96"	24W Up 48W Down	30, 35, 40, 50	CALL
HSLSLPFR96LUS36WD72WDMV40KWH-HC401WH	96"	36W Up 72W Down	30, 35, 40, 50	CALL

For 0-10 Dimming. Change 401WH to 4015WWH and add \$5.00. For Emergency, add EM and \$115. Consult for other Direct/Indirect Options. Change FR to BN for Brushed Nickel and add \$25 per 4 ft. For LED arrays angled for partial up and downlight add UD after S. Consult for smart sensor option.

Add this Emergency to most LED Fixtures with Array and Driver for \$115.00



This **ILB-CP10** from IOTA Engineering is a UL Classified LED emergency driver that allows the same LED fixture to be used for both normal and emergency operation. In the event of a power failure, the ILB-CP10 switches to the emergency mode and operates the existing fixture **90 minutes**. The unit contains a battery, charger and converter circuit in a single can and is available in different mounting configurations for individual fixture requirements. The ILB-CP10 maintains the output wattage even as the system voltage diminishes. Also suitable for field installation.



INPUT VOLTAGE: 120-277Vac±10%  
OUTPUT CURRENT: 550-245mA  
OUTPUT VOLTAGE: 20-54Vdc

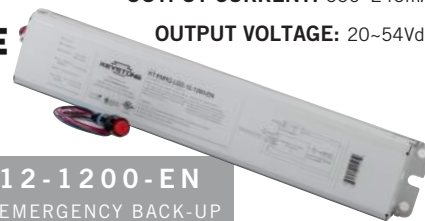

**KT-EMRG-LED-12-1200-EN**  
CONSTANT WATTAGE LED EMERGENCY BACK-UP

**12W Constant Wattage - Ballast Battery Backup - Damp Location - 120-277V**  
Includes driver, separately housed 1200mAh Ni-Cd battery and 0.7" x 8" 1200 Lumen LED module for complete emergency lighting installations. When AC power fails, the driver will power the LED for a minimum of **90 minutes** emergency illumination. Easy installation in existing LED or fluorescent fixtures with wiring diagrams and labels on all parts. Mounting hardware included. Full 5 year warranty on all components.  
Output Current 1000 mA-200mA - Output Voltage 12-41 Vdc

**LINEAR INDIRECT LIGHTING (NOT AVAILABLE FOR DOWNLIGHT ONLY)**



LINMW  
Matte White Lens



LINLV  
Louvered



LINPF  
Perforated

ITEM NO.	SIZE	WATTS/LUMENS	Color Temp (X100 Kelvins)	SPECIAL PRICE
HSLLINMW48LUS24WD12WDMV40KWH-HC301WH	48"	24W Up 12W Down	30, 35, 40, 50	CALL
HSLLINMW48LUS36WD18WDMV40KWH-HC301WH	48"	36W Up 18W Down	30, 35, 40, 50	CALL
HSLLINMW96LUS48WD24WDMV40KWH-HC301WH	96"	48W Up 24W Down	30, 35, 40, 50	CALL
HSLLINMW96LUS72WD36WDMV40KWH-HC301WH	96"	72W Up 36W Down	30, 35, 40, 50	CALL

For Emergency, add EM and \$115. For Dimming, change "HC301WH" to "HC3015WWH" and add \$5.00. Consult for other Direct/Indirect Options. Change WH to BN for Brushed Nickel and add \$25 per 4 ft. For Louver, change MW to LV and add \$30 for 4ft and \$60 for 8ft. For Perforated, change MW to PF and deduct \$25 per 4ft.

**LED HIGH BAY BAFFLE (IDEAL FOR GENERAL MERCHANDISING)**



ITEM NO.	DESCRIPTION	SPECIAL PRICE
HSLFHBL48LS32W4050LW30DMV40K	HI BAY BAFFLE 11.25"W x 48"L x 4.25"H - 4050lm - 4000K - 0-10V dimmable	CALL
HSLFHBL48LS48W5400LW30DMV40K	HI BAY BAFFLE 11.25"W x 48"L x 4.25"H - 5400lm - 4000K - 0-10V dimmable	CALL
HSLFHBL48LS57W6000LW30DMV40K	HI BAY BAFFLE 11.25"W x 48"L x 4.25"H - 6000lm - 4000K - 0-10V dimmable	CALL
HSLFHBL48LH72W7600LW30DMV40K	HI BAY BAFFLE 11.25"W x 48"L x 4.25"H - 7600lm - 4000K - 0-10V dimmable	CALL
HSLFHBL96LS97W10800LW30DMV40K	HI BAY BAFFLE 11.25"W x 96"L x 4.25"H - 10800lm - 4000K - 0-10V dimmable	CALL
HSLFHBL96LS114W12000LW30DMV40K	HI BAY BAFFLE 11.25"W x 96"L x 4.25"H - 12000lm - 4000K - 0-10V dimmable	CALL

Consult for Inlay Lens. For Emergency, add EM for \$115. Available in 3000K, 3500K and 5000K.

For Continuous Runs, add Wire Harnessing, see page E10.

**LED LINEAR STEPPED PENDANT w/LENS**



New Door Frame and Lens is a high style option for LED.

Consult for finish options.

ITEM NO.	DESCRIPTION	SPECIAL PRICE
HSLFHBFR48LS32W4050LW30DMV40K	HI BAY BAFFLE 11.25"W x 48"L x 4.25"H - 4050lm - 4000K - 0-10V dimmable	CALL
HSLFHBFR48LS48W5650LW30DMV40K	HI BAY BAFFLE 11.25"W x 48"L x 4.25"H - 5650lm - 4000K - 0-10V dimmable	CALL
HSLFHBFR48LS57W6400LW30DMV40K	HI BAY BAFFLE 11.25"W x 48"L x 4.25"H - 6400lm - 4000K - 0-10V dimmable	CALL
HSLFHBFR48LH72W8200LW30DMV40K	HI BAY BAFFLE 11.25"W x 48"L x 4.25"H - 8200lm - 4000K - 0-10V dimmable	CALL
HSLFHBFR96LS97W11300LW30DMV40K	HI BAY BAFFLE 11.25"W x 96"L x 4.25"H - 11300lm - 4000K - 0-10V dimmable	CALL
HSLFHBFR96LS114W12800LW30DMV40K	HI BAY BAFFLE 11.25"W x 96"L x 4.25"H - 12800lm - 4000K - 0-10V dimmable	CALL

For Emergency, add EM for \$115. Available in 3000K, 3500K and 5000K.



## LOUVERED 6" DECORATIVE LINEAR



ITEM NO.	DESCRIPTION	SPECIAL PRICE
HSLLSV648LJ48W4000LDMV40KWHHC301WH	6" Louvered Suspended 48"L 48Watt 4000 Lumens 4000K	CALL
HSLLSV648LZ57W4800LDMV40KWHHC301WH	6" Louvered Suspended 48"L 57Watt 4800 Lumens 4000K	CALL
HSLLSV648LZ72W6000LDMV40KWHHC301WH	6" Louvered Suspended 48"L 72Watt 6000 Lumens 4000K	CALL
HSLLSV696LJ48W4000LDMV40KWHHC301WH	6" Louvered Suspended 96"L 48Watt 4000 Lumens 4000K	CALL
HSLLSV696LJ96W8000LDMV40KWHHC301WH	6" Louvered Suspended 96"L 96Watt 8000 Lumens 4000K	CALL
HSLLSV696LZ114W9600LDMV40KWHHC301WH	6" Louvered Suspended 96"L 114Watt 9600 Lumens 4000K	CALL
HSLLSV696LZ144W12000LDMV40KWHHC301WH	6" Louvered Suspended 96"L 144Watt 12000 Lumens 4000K	CALL

Available in 3000K, 3500K and 5000K. For Inlay Lens add MW after LVS6 and add \$10.00. For Emergency, add EM and \$115. For Dimming, change "HC301WH" to "HC3015WWH" and add \$5.00. Available in Black (BK), Silver (SL), Bronze (BZ) or Galvanize (GV) add \$25 per 4ft.

## LOUVERED 8" DECORATIVE LINEAR



Shown in Black (BK).

ITEM NO.	DESCRIPTION	SPECIAL PRICE
HSLLSV48LS48W3800LDMV40KWHHC301WH	8" Louvered Suspended 48"L 48Watt 3800 Lumens 4000K	CALL
HSLLSV48LS57W4300LDMV40KWHHC301WH	8" Louvered Suspended 48"L 57Watt 4300 Lumens 4000K	CALL
HSLLSV48LH72W5500LDMV40KWHHC301WH	8" Louvered Suspended 48"L 72Watt 5500 Lumens 4000K	CALL
HSLLSV96LS48W3800LDMV40KWHHC301WH	8" Louvered Suspended 96"L 48Watt 3800 Lumens 4000K	CALL
HSLLSV96LS97W7600LDMV40KWHHC301WH	8" Louvered Suspended 96"L 96Watt 7600 Lumens 4000K	CALL
HSLLSV96LS114W8600LDMV40KWHHC301WH	8" Louvered Suspended 96"L 114Watt 8600 Lumens 4000K	CALL
HSLLSV96LH144W11000LDMV40KWHHC301WH	8" Louvered Suspended 96"L 144Watt 11000 Lumens 4000K	CALL

Available in 3000K, 3500K and 5000K. For Inlay Lens add MW after LVS and add \$10.00. For Emergency, add EM and \$115. For Dimming, change "HC301WH" to "HC3015WWH" and add \$5.00. Available in Black (BK), Silver (SL), Bronze (BZ) or Galvanize (GV) add \$25 per 4ft.

## MEDIUM BODY DECORATIVE STRIP



ITEM NO.	DESCRIPTION	SPECIAL PRICE
HSLDID48LS48W5800LW30BFDMMV40K	Decorative Strip 48"L 48Watt 5800 Lumens 4000K	CALL
HSLDID48LS57W6500LW30BFDMMV40K	Decorative Strip 48"L 57Watt 6500 Lumens 4000K	CALL
HSLDID48LH72W9200LW30BFDMMV40K	Decorative Strip 48"L 72Watt 7000 Lumens 4000K	CALL
HSLDID96LS114W13000LW30BFDMMV40K	Decorative Strip 96"L 114Watt 13000 Lumens 4000K	CALL
HSLDID96LH144W18400LW30BFDMMV40K	Decorative Strip 96"L 144Watt 18400 Lumens 4000K	CALL

Available in 3000K, 3500K and 5000K. Reflector Options: W30 - White Steel, P10 - Perforated, M24-Full Specular. Basket Options: BP - Perforated, BF - Fine Fluted lens, BL - Smooth White Lens. Consult factory for Brushed Nickel and other finishes.

## WALL LINEAR 2" X 3.5" DOWNLIGHT ONLY (ADD U AFTER L FOR UPLIGHT)



Available in 3000K, 3500K and 5000K.  
See Matching Pendants on page E7.

ITEM NO.	DESCRIPTION	SPECIAL PRICE		
HSL23WSF48LR26W2600LDMV40KWH	2.00" X 3.50" X 48.00" / 26W, 2600L, 4000K	CALL		
HSL23WSF48LR38W3800LDMV40KWH	2.00" X 3.50" X 48.00" / 38W, 3800L, 4000K	CALL		
HSL23WSF48LR45W4500LDMV40KWH	2.00" X 3.50" X 48.00" / 45W, 4500L, 4000K	CALL		
HSL23WSF96LR52W5200LDMV40KWH	2.00" X 3.50" X 96.00" / 52W, 5200L, 4000K	CALL		
HSL23WSF96LR76W7600LDMV40KWH	2.00" X 3.50" X 96.00" / 76W, 7600L, 4000K	CALL		
HSL23WSF96LR90W9000LDMV40KWH	2.00" X 3.50" X 96.00" / 90W, 9000L, 4000K	CALL		
Direct/Indirect	Size	Watts Up/Down	Color Options	SPECIAL PRICE
HSL23WSF48LUR12WD24WDMV40KWH	2.00" X 3.50" X 48"	12 / 24	30, 35, 40, 50	CALL
HSL23WSF48LUR18WD36WDMV40KWH	2.00" X 3.50" X 48"	18 / 36	30, 35, 40, 50	CALL
HSL23WSF96LUR24WD48WDMV40KWH	2.00" X 3.50" X 96"	24 / 48	30, 35, 40, 50	CALL
HSL23WSF96LUR36WD72WDMV40KWH	2.00" X 3.50" X 96"	36 / 72	30, 35, 40, 50	CALL

Remote Emergency available only. For Emergency, add EM for \$115.

## WALL LINEAR 4" X 4" DOWNLIGHT ONLY (ADD U AFTER L FOR UPLIGHT)

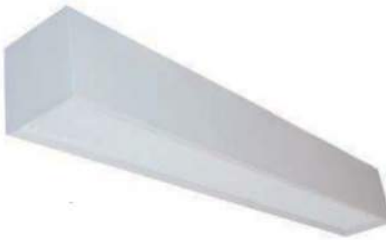

Available in 3000K, 3500K and 5000K.

ITEM NO.	DESCRIPTION	SPECIAL PRICE
<b>Direct</b>		
HSL44WSF48LR24W2400LDMV40KWH	4.00" X 4.00" X 48" / 24W, 2400L, 4000K	CALL
HSL44WSF48LR48W4800LDMV40KWH	4.00" X 4.00" X 48" / 48W, 4800L, 4000K	CALL
HSL44WSF96LR48W4800LDMV40KWH	4.00" X 4.00" X 96" / 48W, 4000K, 4000K	CALL
HSL44WSF96LR96W9600LDMV40KWH	4.00" X 4.00" X 96" / 96W, 9600L, 4000K	CALL

For Emergency, add EM and \$115. Consult for other finishes

## WALL LINEAR 4" X 5" DIRECT / INDIRECT



Available in 3000K, 3500K and 5000K.

ITEM NO.	Size	Watts Up/Down	Color Options	SPECIAL PRICE
HSL45WSF48LUR12WD24WDMV40KWH	4.00" X 5.50" X 48"	12 / 24	30, 35, 40, 50	CALL
HSL45WSF48LUR24WD48WDMV40KWH	4.00" X 5.50" X 48"	18 / 36	30, 35, 40, 50	CALL
HSL45WSF96LUR24WD48WDMV40KWH	4.00" X 5.50" X 96"	24 / 48	30, 35, 40, 50	CALL
HSL45WSF96LUR36WD72WDMV40KW	4.00" X 5.50" X 96"	36 / 72	30, 35, 40, 50	CALL

H For Emergency, add EM and \$115.

## WALL LINEAR 6" X 6"



Available in 3000K, 3500K and 5000K.  
See Matching Pendants or Surface  
Mounts on page E7.

ITEM NO.	DESCRIPTION	SPECIAL PRICE		
HSL66WSF48LR24W2400LDMV40KWH	6.00" X 6.00" X 48" / 24W, 2400L/ Color Temp - 30, 35, 40, 50	CALL		
HSL66WSF48LR48W4800LDMV40KWH	6.00" X 6.00" X 48" / 48W, 4800/ Color Temp - 30, 35, 40, 50	CALL		
HSL66WSF96LR48W4800LDMV40KWH	6.00" X 6.00" X 96" / 48W, 4800/ Color Temp - 30, 35, 40, 50	CALL		
HSL66WSF96LR96W9600LDMV40KWH	6.00" X 6.00" X 96" / 96W, 9600/ Color Temp - 30, 35, 40, 50	CALL		
Direct/Indirect	Size	Watts Up/Down	Color Options	SPECIAL PRICE
HSL66WSF48LUR12WD24WDMV40KWH	6.00" X 6.00" X 48"	12 / 24	30, 35, 40, 50	CALL
HSL66WSF48LUR24WD48WDMV40KWH	6.00" X 6.00" X 48"	18 / 16	30, 35, 40, 50	CALL
HSL66WSF96LUR24WD48WDMV40KWH	6.00" X 6.00" X 96"	24 / 48	30, 35, 40, 50	CALL
HSL66WSF96LUR36WD72WDMV40KWH	6.00" X 6.00" X 96"	36 / 72	30, 35, 40, 50	CALL

Change SF to MW for Matte White Lens.

**NEW Snap Fit Lens**

## WALL LINEAR WINDOW LED WITH DIRECT/INDIRECT LIGHTING



Available in 3000K, 3500K and 5000K.

ITEM NO.	DESCRIPTION	SPECIAL PRICE
<b>Downlight Only</b>		
HLSLWFR48LS48W4800LDMV40KWH	7.60" x 1.9" x 48" / 48W, 4800L, 4000K	CALL
HLSLWFR96LS96W9600LDMV40KWH	7.60" x 1.9" x 96" / 96W, 9600L, 4000K	CALL
<b>Direct/Indirect</b>		
	<b>Size</b>	<b>Watts Up/Down</b>
HLSLWFR48LUS12WD24WDMV40KWH	7.60" x 1.9" x 48"	12 / 24
HLSLWFR48LUS18WD36WDMV40KWH	7.60" x 1.9" x 48"	18 / 36
HLSLWFR96LUS24WD48WDMV40KWH	7.60" x 1.9" x 96"	24 / 48
HLSLWFR96LUS36WD72WDMV40KWH	7.60" x 1.9" x 96"	36 / 72
	<b>Color Options</b>	
	30, 35, 40, 50	CALL
	30, 35, 40, 50	CALL
	30, 35, 40, 50	CALL
	30, 35, 40, 50	CALL

For Emergency, add EM for \$115. Available in variety of finishes

## LINEAR INDIRECT LIGHTING (Not Available Downlight Only)



Louvered (LV)

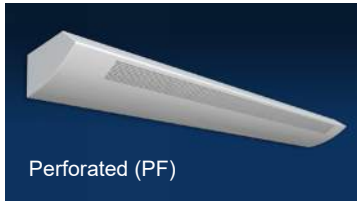

Perforated (PF)



Matte White Lens (MV)

ITEM NO.	SIZE	WATTS/LUMENS	Color Temp (X100 Kelvins)	SPECIAL PRICE
HSLWLINMW48LUS24WD12WDMV40KWH	48"	24W Up 12W Down	30, 35, 40, 50	CALL
HSLWLINMW48LUS36WD18WDMV40KWH	48"	36W Up 18W Down	30, 35, 40, 50	CALL
HSLWLINMW96LUS48WD24WDMV40KWH	96"	48W Up 24W Down	30, 35, 40, 50	CALL
HSLWLINMW96LUS72WD36WDMV40KWH	96"	72W Up 36W Down	30, 35, 40, 50	CALL

For 0-10 Dimming. For Emergency, add EM and \$115.

Consult for other Direct/Indirect Options. Change WH to BN for Brushed Nickel and add \$25 per 4 ft.

For Louver, change MW to LV and add \$30 for 4ft and \$60 for 8ft.

For Perforated, change MW to PF and deduct \$25 per 4ft.

Most fixture are available in these finishes



Silver (SL)



Red (RD)



Black (BK)



Bronze (BZ)



Iron (IN)

## LED 45 DEGREE LINEAR STRIP (IDEAL FOR WALL AND CORNER APPLICATIONS)



ITEM NO.	SIZE	WATTS/LUMENS	Color Temp (X100 Kelvins)	SPECIAL PRICE
HSLCU45FR48LFRS35W4500LDMV40K	4.25" x 48"	35W / 4500L	30, 35, 40, 50	CALL
HSLCU45FR48LFRS48W6000LDMV40K	4.25" x 48"	48W / 6000L	30, 35, 40, 50	CALL
HSLCU45FR48LFRS57W7100LDMV40K	4.25" x 48"	57W / 7100L	30, 35, 40, 50	CALL
HSLCU45FR96LFRS70W9100LDMV40K	4.25" x 96"	70W / 9100L	30, 35, 40, 50	CALL
HSLCU45FR96LFRS97W11900LDMV40K	4.25" x 96"	97W / 11900L	30, 35, 40, 50	CALL
HSLCU45FR96LFRS118W14200LDMV40	4.25" x 96"	118W / 14200L	30, 35, 40, 50	CALL

K For Emergency, add EM for \$115.

### Note to our Valued Customers:

As the current climate of tariff policies continues to impact pricing, LITE can be a great resource to help minimize the impact on your purchases. Manufacturing domestically, we have the fixture advantage. We can also recommend or source alternative products that might be more cost effective. Please check with your sales consultant for options and current pricing.



**4" Wall Linear**



**4" Up and Down Wall**



**Linear Wall Downlight**



**VAN Series**



**Stairwell**



**Stairwell/StepDim**



**Stairwell/StepDim**



**LED Linkable Undercabinet**



**LED Dimmable Task**



**LED High Lumen Tape**



**Remote Driver**



## 4" WALL LINEAR



ITEM NO.	SIZE	WATTS/ LUMENS	COLOR OPTIONS (X100 Kelvins)	SPECIAL PRICE
HSL555A24LF24W2900LDMV40KWH	4.3" x 24"	24 / 2900	30, 35, 40, 50	CALL
HSL555A24LF28W3200LDMV40KWH	4.3" x 24"	28 / 3200	30, 35, 40, 50	CALL
HSL555A24LF35W4000LDMV40KWH	4.3" x 24"	35 / 4000	30, 35, 40, 50	CALL
HSL555A48LF30W4100LDMV40KWH*	4.3" x 48"	30 / 4100	30, 35, 40, 50	CALL
HSL555A48LF48W6000LDMV40KWH*	4.3" x 48"	48 / 6000	30, 35, 40, 50	CALL
HSL555A48LF57W6900LDMV40KWH*	4.3" x 48"	57 / 6900	30, 35, 40, 50	CALL
HSL555A48LH72W8800LDMV40KWH	4.3" x 48"	72 / 8800	30, 35, 40, 50	CALL

For Matt White Lens, change "A" to "MW".

For Emergency, add EM for \$115.

## 4' UP AND DOWN WALL FIXTURE

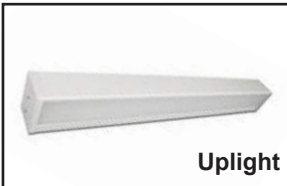

Uplight

ITEM NO.	SIZE	WATTS/ LUMENS	COLOR OPTIONS (X100 Kelvins)	SPECIAL PRICE
HSL215A24L1U1DS24W2400LDFDMV40K	4.375" x 24.15"L x 5.364"	24 / 2400	30, 35, 40, 50	CALL
HSL215A24L1U2DS36W3600LDFDMV40K	4.375" x 24.15"L x 5.364"	36 / 3600	30, 35, 40, 50	CALL
HSL215A24L2U2DS48W4800LDFDMV40K	4.375" x 24.15"L x 5.364"	48 / 4800	30, 35, 40, 50	CALL
HSL215A24L2U1DS36W3600LDFDMV40K	4.375" x 24.15"L x 5.364"	36 / 3600	30, 35, 40, 50	CALL
HSL215A48L1U1DS48W4800LDFDMV40K	4.375" x 48"L x 5.364"	48 / 4800	30, 35, 40, 50	CALL
HSL215A48L1U2DS73W7200LDFDMV40K	4.375" x 48"L x 5.364"	73 / 7200	30, 35, 40, 50	CALL
HSL215A48L2U2DS97W9600LDFDMV40K	4.375" x 48"L x 5.364"	97 / 9600	30, 35, 40, 50	CALL
HSL215A48L2U1DS73W7200LDFDMV40K	4.375" x 48"L x 5.364"	73 / 7200	30, 35, 40, 50	CALL

For separately switching, add 11 after DMV and add \$25. For 4 way pull chain add \$5.

For Emergency, add EM for \$115.

## LINEAR WALL DOWNLIGHT (IDEAL FOR PERIMETER WALL LIGHTING)



ITEM NO.	SIZE	WATTS/ LUMENS	Color Temp (X100 Kelvins)	SPECIAL PRICE
HSLWDFR48LS30W2400LDMV40KWH	4.25" x 48"	30 / 2400	30, 35, 40, 50	CALL
HSLWDFR48LS48W3500LDMV40KWH	4.25" x 48"	48 / 3500	30, 35, 40, 50	CALL
HSLWDFR48LS57W4000LDMV40KWH	4.25" x 48"	57 / 4000	30, 35, 40, 50	CALL

## VAN SERIES



ITEM NO.	DESCRIPTION	SPECIAL PRICE
HSLVAN24LS24W2250LDMV40KSW	4.75" x 4.00" x 24.125" / 24W, 2250L, 4000K	CALL
HSLVAN24LS28W2550LDMV40KSW	4.75" x 4.00" x 24.125" / 28W, 2550L, 4000K	CALL
HSLVAN48LS32W3250LDMV40KSW	4.75" x 4.00" x 48.125" / 32W, 3250L, 4000K	CALL
HSLVAN48LS48W4500LDMV40KSW	4.75" x 4.00" x 48.125" / 48W, 4500L, 4000K	CALL
HSLVAN48LS57W5100LDMV40KSW	4.75" x 4.00" x 48.125" / 57W, 5100L, 4000K	CALL

Change SW to BM (Black Marble), IV (Ivory Marble), etc for end cap in different finish. See specification for more end cap choices. Available in 3000K, 3500K and 4000K.

Add after VAN, WR for White Ribbed, CR - Clear Ribbed, FR - For Frosted Ribbed.

# Stairwell Lighting

Stairwells provide one of the easiest opportunities to provide energy savings. Reduce the light output when no one is in the stairwell and increase light when anyone enters the stairwell.

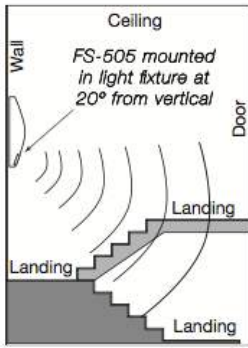

FS-505 Mounted in Stairwell

Ultrasonic technology for open area detection and line-of-sight obstructions.

Choose the percentage of light output (XX) that you want when space is unoccupied.

## STAIRWELL STANDARD

ITEM NO.	SIZE (W X L)	Watts / Lumens	Color Options (X100 Kelvins)	SPECIAL PRICE
HLSSTWFR24LE15W2050LDMV(XX)40K	4.4" x 24"	15 / 2050	30, 35, 40, 50	CALL
HLSSTWFR24LE24W3000LDMV(XX)40K	4.4" x 24"	24 / 3000	30, 35, 40, 50	CALL
HLSSTWFR48LE48W6000LDMV(XX)40K	4.4" x 48"	48 / 6000	30, 35, 40, 50	CALL
HLSSTWFR48LE57W6900LDMV(XX)40K	4.4" x 48"	57 / 6900	30, 35, 40, 50	CALL

(XX) for Percentage of Light Output When it is not Occupied. For Emergency, add EM for \$115.

## STAIRWELL LINEAR LED w/ 20% Output and Emergency Unit

ITEM NO.	SIZE	WATTS / LUMENS	COLOR OPTIONS (X100 Kelvins)	SPECIAL PRICE
HLSSTWFR48LY46W5500LDMV(20)40KEM	4.4" x 48"	46 / 5500	30, 35, 40, 50	CALL

Fixed output driver. No variations.

## STAIRWELL LINEAR LED WITH STEP DIM DRIVER

(Consult for other Driver Options)

ITEM NO.	DESCRIPTION	SPECIAL PRICE
HLSSTRMW24LE27W2000LDMV(XX)40K	2 ft / 27W, 2000L with Variable Output, Color Temp 30, 35, 40, 50	CALL
HLSSTRMW48LE36W2800LDMV(XX)40K	4 ft / 36W, 2800L with Variable Output, Color Temp 30, 35, 40, 50	CALL
HLSSTSMW24LE27W2000LDMV(XX)40K	2 ft / 27W, 2000L with Variable Output, Color Temp 30, 35, 40, 50	CALL
HLSSTSMW48LE36W2800LDMV(XX)40K	4 ft / 36W, 2800L with Variable Output, Color Temp 30, 35, 40, 50	CALL

(XX) for Percentage of Light Output When it is not Occupied. For Emergency, add EM for \$115.

## STAIRWELL LINEAR LED WITH STEP DIM DRIVER

(Consult for other Driver Options)

ITEM NO.	SIZE	WATTS / LUMENS	COLOR OPTIONS (X100 Kelvins)	SPECIAL PRICE
HLS213A24LE15W2050LDMV(XX)40K	4.4" x 24"	15 / 2050	30, 35, 40, 50	CALL
HLS213A24LE24W3000LDMV(XX)40K	4.4" x 24"	24 / 3000	30, 35, 40, 50	CALL
HLS213A48LE30W4100LDMV(XX)40K*	4.4" x 48"	30 / 4100	30, 35, 40, 50	CALL
HLS213A48LE48W6000LDMV(XX)40K*	4.4" x 48"	48 / 6000	30, 35, 40, 50	CALL
HLS213A48LE57W6900LDMV(XX)40K*	4.4" x 48"	57 / 6900	30, 35, 40, 50	CALL

(XX) for Percentage of Light Output When it is not Occupied. Emergency, add EM for \$115.

\*Check DLC listing for most current/additional Wattage and Lumen Options.



## LED Linkable Undercabinet



ITEM NO.	DESCRIPTION	SPECIAL PRICE
HSLUC9L5WE120	9" LED undercabinet lights, Dimmable, linkable, 5w	CALL
HSLUC12L6WE120	12" LED undercabinet lights, Dimmable, linkable, 6w	CALL
HSLUC18L9WE120	18" LED undercabinet lights, Dimmable, linkable, 9w	CALL
HSLUC24L11WE120	24" LED undercabinet lights, Dimmable, linkable, 11w	CALL
HSLUC33L13WE120	33" LED undercabinet lights, Dimmable, linkable, 13w	CALL
HSLUC42L16WE120	42" LED undercabinet lights, Dimmable, linkable, 16w	CALL

Undercabinets come with power cord, joiner cable, butt connector and a BX connector.

## LED Dimmable Undercabinet Task Lighting



ITEM NO.	SIZE	WATTS / LUMENS	COLOR OPTIONS (x100) Kelvins	SPECIAL PRICE
HSLLEDDUCL12WH30	2" 12"	5 / 250	30	CALL
HSLLEDDUCL18WH30	2" x 18"	8 / 400	30	CALL
HSLLEDDUCL24WH30	2" x 24"	11 / 525	30	CALL
HSLLEDDUCLJBOX	Junction Box for hardwire			CALL

Each fixture comes with mini coupler and 15" joiner cord, 42" cord and plug with integral on/off switch.

## LED HIGH LUMEN TAPE



ITEM NO.	DESCRIPTION	SPECIAL PRICE
HSLT5050L24V27K*	LED HIGH LUMEN TAPE 1ft PIECES, 4.32W/FT, 180LM/FT, 24v, 27K	CALL
HSLT5050L24V30K*	LED HIGH LUMEN TAPE 1ft PIECES, 4.32W/FT, 185LM/FT, 24v, 30K	CALL
HSLT5050L24V40K*	LED HIGH LUMEN TAPE 1ft PIECES, 4.32W/FT, 189LM/FT, 24v, 40K	CALL
HSLTHWCON10	LED 10 foot HARDWIRE CONNECTOR	CALL
HSLTEXT4IN	LED 4 inch 4 PIN TAPE JUMPER CABLE MtoF	CALL
HSLTEXT12IN	LED 12 inch 4 PIN TAPE JUMPER CABLE MtoF	CALL
HSLTEXT36IN	LED 36 inch 4 PIN TAPE JUMPER CABLE MtoF	CALL
HSLTCON4M4M	LED 4 PIN TAPE MALE to MALE CONNECTOR	CALL
HSLTCON	LED 4 PIN TAPE MALE to MALE T CONNECTOR	CALL

\*Priced per Foot, 15ft/Reel. Specify remote driver.

## REMOTE DRIVER (Dimmable with any standard MLV Triac (leading edge) control)



ITEM NO.	DESCRIPTION	Watts	SPECIAL PRICE
HSLMTIM60L24DC	Magnitude Magnetic Driver 60W 24VDC Encased	60	CALL
HSLMTIM100L24DC	Magnitude Magnetic Driver 96W 24VDC Encased	96	CALL
HSLMTIM150L24DC	Magnitude Magnetic Driver 150W 24VDC Encased	150	CALL

Consult for other drivers and wattages.



DFUCLL



DFCKFR



RKCB



Troffer Retrofit



Strip Retrofit Kit

Strip Ballast  
Cover Retrofit

Linear Wall Down



CTC Retrofits



CTC Retrofits Cover Retrofit

### Note to our Valued Customers:

As the current climate of tariff policies continues to impact pricing, LITE can be a great resource to help minimize the impact on your purchases. Manufacturing domestically, we have the fixture advantage. We can also recommend or source alternative products that might be more cost effective. Please check with your sales consultant for options and current pricing.



## LED Retrofits

### All-In-One Retrofit LED Troffer Kits

Convert an existing linear fluorescent fixture to a state-of-the-art Linear LED fixture in minutes with this LED All-In-One Retrofit Kit. Choose from two great styles of Linear LED fixtures that will not only increase lighting performance, save energy and reduce maintenance but provide a fresh new look for the space. The LED Center Basket All-In-One Retrofit provides the look of a popular direct/indirect linear fixture with a special designed reflector and LED lens to provide comfortable, abundant lighting. The Chicklet Retrofit Kit provides a luminous pillow styled lens and a high level of lighting with a dramatic appearance. Each kit mounts in minutes with all the LED components neatly engineered in one simple frame that mounts to two side rails that mount between the existing fixture body and the T-bar. Available in 2x2 or 2x4 sizes and a variety of wattage, lumens and color temperatures.

#### CENTER BASKET



**Install in Minutes:**  
Place Rails between fixture and T-Bar on each side. Then latch and secure All-In-One-LED-Retrofit into place.



ITEM NO.	ITEM NO.	SPECIAL PRICE
HSLDFUCLL22LF24W3000LDMV40K*	Door Frame Center Basket Retro 2x2 24W, 2400 Lumen, 40K, 0-10V Dimming Capable	CALL
HSLDFUCLL22LF28W3350LDMV40K	Door Frame Center Basket Retro 2x2 28W, 2800 Lumen, 40K, 0-10V Dimming Capable	CALL
HSLDFUCLL22LF35W4300LDMV40K	Door Frame Center Basket Retro 2x2 32W, 3200 Lumen, 40K, 0-10V Dimming Capable	CALL
HSLDFUCLL24LF32W4650LDMV40K*	Door Frame Center Basket Retro 2x4 32W, 3200 Lumen, 40K, 0-10V Dimming Capable	CALL
HSLDFUCLL24LF48W6750LDMV40K*	Door Frame Center Basket Retro 2x4 48W, 4800 Lumen, 40K, 0-10V Dimming Capable	CALL
HSLDFUCLL24LF57W7800LDMV40K*	Door Frame Center Basket Retro 2x4 57W, 5700 Lumen, 40K, 0-10V Dimming Capable	CALL
HSLDFUCLL24LF62W8100LDMV40K*	Door Frame Center Basket Retro 2x4 62W, 8100 Lumen, 40K, 0-10V Dimming Capable	CALL

For other color temperatures, replace 40K with 30K, 35K or 50K. Consult for other wattage and lumen options and emergency driver. Consult for 1x4 version. Check DLC listing for most current/additional Wattage and Lumen Options.

#### CHICKLET FROSTED LENS



Watch Installation Video on YouTube.com, Texas Fluorescents Channel <https://www.youtube.com/channel/UCxulbwriXpLi2xxyGhGe3YQ>

ITEM NO.	ITEM NO.	SPECIAL PRICE
HSLDFCKFR22LF24W2400LDMV40K	Door Frame Chicklet Frosted Lens Retro 2x2 24W, 2400 Lumen, 40K, 0-10V Dimming Capable	CALL
HSLDFCKFR22LF28W2800LDMV40K	Door Frame Chicklet Frosted Lens Retro 2x2 28W, 2800 Lumen, 40K, 0-10V Dimming Capable	CALL
HSLDFCKFR22LF32W3200LDMV40K	Door Frame Chicklet Frosted Lens Retro 2x2 32W, 3200 Lumen, 40K, 0-10V Dimming Capable	CALL
HSLDFCKFR24LF32W3200LDMV40K	Door Frame Chicklet Frosted Lens Retro 2x4 32W, 3200 Lumen, 40K, 0-10V Dimming Capable	CALL
HSLDFCKFR24LF40W4000LDMV40K	Door Frame Chicklet Frosted Lens Retro 2x4 40W, 4000 Lumen, 40K, 0-10V Dimming Capable	CALL
HSLDFCKFR24LF48W4800LDMV40K	Door Frame Chicklet Frosted Lens Retro 2x4 48W, 4800 Lumen, 40K, 0-10V Dimming Capable	CALL
HSLDFCKFR24LF57W5700LDMV40K	Door Frame Chicklet Frosted Lens Retro 2x4 57W, 5700 Lumen, 40K, 0-10V Dimming Capable	CALL

For other color temperatures, replace 40K with 30K, 35K or 50K. Consult for other wattage and lumen options and emergency driver. Consult for 1x4 version.

## Retrofit Your Store To Stand Out and Save Energy



LED Troffer Retrofit Kit Makes Sally Beauty Stand Out.

### VL LED CENTER BASKET RETROFIT

ITEM NO.	DESCRIPTION	SPECIAL PRICE
HSLRKC22L36W4680LDMV40K*	22.52" x 20.67" x 2.6" / 36W, 4680 Lumens, 4000K	CALL
HSLRKC22L36W4680LDMV50K*	22.52" x 20.67" x 2.6" / 36W, 4680 Lumens, 5000K	CALL
HSLRKC24L36W4900LDMV40K	20.67" x 47.8" x 2.6" / 36W, 4902 Lumens, 4000K	CALL
HSLRKC24L36W4900LDMV50K	20.67" x 47.8" x 2.6" / 36W, 4902 Lumens, 5000K	CALL

For Emergency, add EM for \$115.

### LED TROFFER RETROFIT KIT

(INSTALLS IN FLUORESCENT TROFFER IN UNDER 5 MINUTES)

ITEM NO.	DESCRIPTION	SPECIAL PRICE
HSL22CF24W2600LW10DMV40K*	2x2 / 24W, 2600L / Color Temp - 30, 35, 40, 50	CALL
HSL22CF28W3000LW10DMV40K*	2x2 / 28W, 3000L / Color Temp - 30, 35, 40, 50	CALL
HSL22CF35W3600LW10DMV40K*	2x2 / 35W, 4400L / Color Temp - 30, 35, 40, 50	CALL
HSL24CF35W3650LW10DMV40K*	2x4 / 35W, 3650L / Color Temp - 30, 35, 40, 50	CALL
HSL24CF48W5650LW10DMV40K*	2x4 / 48W, 5650L / Color Temp - 30, 35, 40, 50	CALL
HSL24CF56W6050LW10DMV40K*	2x4 / 56W, 6050L / Color Temp - 30, 35, 40, 50	CALL

For Emergency, add EM for \$115.

### LED TROFFER RETROFIT KIT w/INTEGRAL SENSOR

ITEM NO.	DESCRIPTION	SPECIAL PRICE
HLSM22CLY28W2850LVDMV40K	2x2 / 28W, 2850L / Color Temp - 30, 35, 40, 50 w/Integral Occupancy Sensor	CALL
HLSM24CLY56W5650LVDMV40K	2x4 / 56W, 5650L / Color Temp - 30, 35, 40, 50 w/Integral Occupancy Sensor	CALL

### VL LED TROFFER RETROFIT

ITEM NO.	DESCRIPTION	SPECIAL PRICE
HSL24CV46W6200LDMV40K	2x4 / 46W, 6200L / Color Temp 40	CALL

Fixed output driver. No variations.



Consult for Parabolic Retrofit Kit



## LED Strip Retrofit Kits



**WARNING:** If you have this fixture in 4 or 8 Foot, You can Retrofit Them and Save over 40% Energy and Reduce Maintenance.

### LED STRIP RETROFIT KIT ROUND PROFILE



Complete fixture available. Add "C" in front of item number and add \$9 per 4 foot



ITEM NO.	DESCRIPTION	SPECIAL PRICE
HSLRSR48LT20W2200LDMV40K	4.25" 48" Strip LED Round Frost Lens 20W 2200 Lumens 4000K	CALL
HSLRSR48LT30W3500LDMV40K*	4.25" 48" Strip LED Round Frost Lens 30W 3500 Lumens 4000K	CALL
HSLRSR48LT41W4300LDMV40K*	4.25" 48" Strip LED Round Frost Lens 41W 4300 Lumens 4000K	CALL
HSLRSR48LT58W6700LDMV40K*	4.25" 48" Strip LED Round Frost Lens 58W 6700 Lumens 4000K	CALL
HSLRSR96LT40W4400LDMV40K	4.25" 96" Strip LED Round Frost Lens 40W 4400 Lumens 4000K	CALL
HSLRSR96LT60W6900LDMV40K*	4.25" 96" Strip LED Round Frost Lens 60W 6900 Lumens 4000K	CALL
HSLRSR96LT82W8900LDMV40K*	4.25" 96" Strip LED Round Frost Lens 82W 8900 Lumens 4000K	CALL
HSLRSR96LT116W13400LDMV40K*	4.25" 96" Strip LED Round Frost Lens 116W 13400 Lumens 4000K	CALL

For Emergency, add EM for \$115. Available in 3000K, 3500K, and 5000K.

### LED STRIP RETROFIT KIT FLAT PROFILE



Complete fixture available. Add "C" in front of item number and add \$9 per 4 foot

ITEM NO.	DESCRIPTION	SPECIAL PRICE
HSLRSF48LT20W2000LDMV40K	4.25" 48" Strip LED Flat Frost Lens 20W 2000 Lumens 4000K	CALL
HSLRSF48LT30W3000LDMV40K	4.25" 48" Strip LED Flat Frost Lens 30W 3000 Lumens 4000K	CALL
HSLRSF48LT41W4100LDMV40K	4.25" 48" Strip LED Flat Frost Lens 41W 4100 Lumens 4000K	CALL
HSLRSF48LT58W5800LDMV40K	4.25" 48" Strip LED Flat Frost Lens 58W 5800 Lumens 4000K	CALL
HSLRSF96LT40W4000LDMV40K	4.25" 96" Strip LED Flat Frost Lens 40W 4000 Lumens 4000K	CALL
HSLRSF96LT60W6000LDMV40K	4.25" 96" Strip LED Flat Frost Lens 60W 6000 Lumens 4000K	CALL
HSLRSF96LT82W8200LDMV40K	4.25" 96" Strip LED Flat Frost Lens 82W 8200 Lumens 4000K	CALL
HSLRSF96LT116W11600LDMV40K	4.25" 96" Strip LED Flat Frost Lens 116W 11600 Lumens 4000K	CALL

For Emergency, add EM for \$115. Available in 3000K, 3500K and 5000K. Consult to retrofit 5" strip.

### ENCLOSED STRIP RETROFIT KIT BEST VALUE



ITEM NO.	DESCRIPTION	SPECIAL PRICE
HSLRFSFFR24LJ12W1200LDMV40K	4.25" x 3.5" x 24.00" / 12W, 1200L, 4000K	CALL
HSLRFSFFR48LJ24W2600LDMV40K	4.25" x 3.5" x 48.00" / 24W, 2600L, 4000K	CALL
HSLRFSFFR48LJ48W5400LDMV40K	4.25" x 3.5" x 48.00" / 48W, 5400L, 4000K	CALL
HSLRFSFFR48LZ57W6200LDMV40K	4.25" x 3.5" x 48.00" / 57W, 6200L, 4000K	CALL
HSLRFSFFR96LJ62W6600LDMV40K	4.25" x 3.5" x 96.00" / 62W, 6600L, 4000K	CALL
HSLRFSFFR96LZ114W12400LDMV40K	4.25" x 3.5" x 96.00" / 114W, 12400L, 4000K	CALL

For Emergency, add EM for \$115. Available in 3000K, 3500K and 5000K. Consult for retrofit 5" strip.

**LED STRIP BALLAST COVER RETROFIT KIT (FOR 4.25" OR 5" STRIPS)**



Check Sales for Frosted lens.



ITEM NO.	SIZE (W X L)	Watts / Lumens	Color Options (X100 Kelvins)	SPECIAL PRICE
HSL4RB421F24W3500LDMV40K*	4.25" x 48"	24 / 3500	30, 35, 40, 50	CALL
HSL4RB421F48W6500LDMV40K*	4.25" x 48"	48 / 6500	30, 35, 40, 50	CALL
HSL4RB421F57W7900LDMV40K*	4.25" x 48"	57 / 7900	30, 35, 40, 50	CALL
HSL4RB501F24W3500LDMV40K*	5" x 48"	24 / 3500	30, 35, 40, 50	CALL
HSL4RB501F48W6500LDMV40K*	5" x 48"	48 / 6500	30, 35, 40, 50	CALL
HSL4RB501F57W7900LDMV40K*	5" x 48"	57 / 7900	30, 35, 40, 50	CALL
HSL8RB421F48W6950LDMV40K*	4.25" x 96"	48 / 6950	30, 35, 40, 50	CALL
HSL8RB421F97W13100LDMV40K*	4.25" x 96"	97 / 13100	30, 35, 40, 50	CALL
HSL8RB421F118W15800LDMV40K*	4.25" x 96"	118 / 15800	30, 35, 40, 50	CALL
HSL8RB501F48W6950LDMV40K*	5" x 96"	48 / 6950	30, 35, 40, 50	CALL
HSL8RB501F97W13100LDMV40K*	5" x 96"	97 / 13100	30, 35, 40, 50	CALL
HSL8RB501F118W15800LDMV40K*	5" x 96"	118 / 15800	30, 35, 40, 50	CALL

For Emergency, add EM for \$115.

**LINEAR WALL DOWN RETROFIT (IDEAL TO RETROFIT PERIMETER WALL LIGHTING)**



Fully Luminous Lens for beautiful look.

ITEM NO.	SIZE	WATTS/ LUMENS	Color Temp (X100 Kelvins)	SPECIAL PRICE
HSLRLWDFR48LS30W4100LDMV40K	4.25" x 48"	30 / 4100	30, 35, 40, 50	CALL
HSLRLWDFR48LS48W6000LDMV40K	4.25" x 48"	48 / 6000	30, 35, 40, 50	CALL
HSLRLWDFR48LS57W6900LDMV40K	4.25" x 48"	57 / 6900	30, 35, 40, 50	CALL

**CTC / WALL FIXTURE RETROFITS (AC WITH DRIVER ON BOARD AND HEAT SINK)**



ITEM NO.	DESCRIPTION	SPECIAL PRICE
HSLEOS12W900LD12030KSQ	EOS Array w/6" Sq Alum Heat Sink - 12W, 900L, 3000K	CALL
HSLEOS12W1000LD12040KSQ	EOS Array w/6" Sq Alum Heat Sink - 12W, 1000L, 4000K	CALL
HSLEOS15W1350LD12030KSQ	EOS Array w/8" Sq Alum Heat Sink - 15W, 1350L, 3000K	CALL
HSLEOS15W1400LD12040KSQ	EOS Array w/8" Sq Alum Heat Sink - 15W, 1400L, 4000K	CALL
HSLEOS22W1850LD12030KSQ	EOS Array w/8" Sq Alum Heat Sink - 22W, 1850L, 3000K	CALL
HSLEOS22W1900LD12040KSQ	EOS Array w/8" Sq Alum Heat Sink - 22W, 1900L, 4000K	CALL

Dimmable with standard dimmer. UL Classified for retrofit

**CTC RETROFIT FOR 11" OR 14" WITH HEAT SINK (DIMMABLE W/STANDARD DIMMER)**



ITEM NO.	DESCRIPTION	SPECIAL PRICE
HSLDAC15W1350LD12040K	LED Array 120V for 11" CTC 15W, 1350L / Color Temp 30, 40, 50	CALL
HSLDAC15W1350LD12050K	LED Array 120V for 14" CTC 25W, 1850L / Color Temp 30, 40, 50	CALL





Low Profile Cloud



Eclipse



Contemporary Cloud



PUF Series

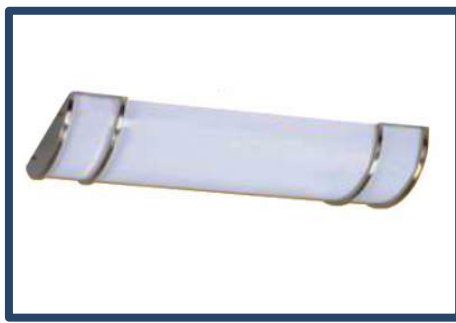

Spill Ring



Crown



Spill Ring Bath



Vanity Series



Crown



Close to Ceiling



Dome



Ultra Thin Downlight



MicroSurface Mount



TDL



Ceiling/Wall Retrofits

## Note to our Valued Customers:

As the current climate of tariff policies continues to impact pricing, LITE can be a great resource to help minimize the impact on your purchases. Manufacturing domestically, we have the fixture advantage. We can also recommend or source alternative products that might be more cost effective. Please check with your sales consultant for options and current pricing.

## LOW PROFILE CLOUD (EXCLUSIVELY FOR LED ARRAYS - SHALLOWEST EVER)



ITEM NO.	DESCRIPTION	SPECIAL PRICE
HSLPCMW24LV22W2000LG120*	11" x 24" x 3" / 22W, 2000L / Color Temp 30, 35, 40, 50	CALL
HSLPCMW48LQ41W4200LG120*	11" x 48" x 3" / 41W, 4200L / Color Temp 30, 35, 40, 50	CALL

## LOW PROFILE CLOUD (0-10V DIMMING)

HSLPCMW24LS20W2250LDMV40K	11" x 24" x 3" / 20W, 2250L / 0-10V Dimming / Color Temp 30, 35, 40, 50	CALL
HSLPCMW24LS24W2600LDMV40K	11" x 24" x 3" / 24W, 2600L / 0-10V Dimming / Color Temp 30, 35, 40, 50	CALL
HSLPCMW24LS28W3000LDMV40K	11" x 24" x 3" / 28W, 3000L / 0-10V Dimming / Color Temp 30, 35, 40, 50	CALL
HSLPCMW48LS40W4550LDMV40K	11" x 48" x 3" / 40W, 4550L / 0-10V Dimming / Color Temp 30, 35, 40, 50	CALL
HSLPCMW48LS48W5200LDMV40K	11" x 48" x 3" / 48W, 5200L / 0-10V Dimming / Color Temp 30, 35, 40, 50	CALL
HSLPCMW48LS57W6050LDMV40K	11" x 48" x 3" / 57W, 6050L / 0-10V Dimming / Color Temp 30, 35, 40, 50	CALL

\*120V only and 2 wire dimming.

## ECLIPSE (4 SIZES TO MATCH YOUR APPLICATION)

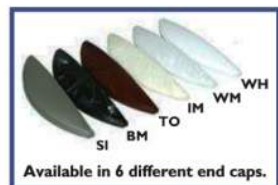

ITEM NO.	SIZE (W X L)	Watts / Lumens	Color Options (X100 Kelvins)	SPECIAL PRICE
HSLECLMW224LS24W2000DMV40KWH	9.5" x 24"	24 / 2000	30, 35, 40, 50	CALL
HSLECLMW224LH36W2900LDMV40KWH	9.5" x 24"	36 / 2900	30, 35, 40, 50	CALL
HSLECLMW424LS48W4000LDMV40KWH	16.5" x 24"	48 / 4000	30, 35, 40, 50	CALL
HSLECLMW248LS32W2900LDMV40KWH	9.5" x 48"	32 / 2900	30, 35, 40, 50	CALL
HSLECLMW248LS48W4000LDMV40KWH	9.5" x 48"	48 / 4000	30, 35, 40, 50	CALL
HSLECLMW248LS57W4500LDMV40KWH	9.5" x 48"	57 / 4500	30, 35, 40, 50	CALL
HSLECLMW248LH72W5800LDMV40KWH	9.5" x 48"	72 / 5800	30, 35, 40, 50	CALL
HSLECLMW448LS96W8000LDMV40KWH	16.5" x 48"	96 / 8000	30, 35, 40, 50	CALL

Finishes for End Caps: SL-Silver, BM-Black Marble, TO- Tortoise, IM-Ivory, WM-White Marble, WH-White  
Available in 3000K, 3500K and 5000K.

## CONTEMPORARY CLOUD



ITEM NO.	SIZE (W X L)	Watts / Lumens	Color Options (X100 Kelvins)	SPECIAL PRICE
HSLCLMMW248LS32W3450LDMV40K	9.75" x 48"	32 / 3450	30, 35, 40, 50	CALL
HSLCLMMW248LS48W4800LDMV40K	9.75" x 48"	48 / 4800	30, 35, 40, 50	CALL
HSLCLMMW248LS57W5400LDMV40K	9.75" x 48"	57 / 5400	30, 35, 40, 50	CALL
HSLCLMMW448LS72W7000LDMV40K	13.75" x 48"	72 / 7200	30, 35, 40, 50	CALL
HSLCLMMW448LS97W9600LDMV40K	13.75" x 48"	97 / 9600	30, 35, 40, 50	CALL

Available in 3000K, 3500K and 5000K.

## LED Drivers and Dimming

Most of our LED Linear Fixtures have a Multi-Volt 0-10V Dimming Driver designated by DMV.  
For dimming, use any dimmer that works for 0-10 LED or purchase the Leviton IP710LFZ from us.



Leviton IP710LFZ  
\$54.95  
IllumaTech Preset  
Slide Control

## LED PUF SERIES



ITEM NO.	SIZE (W X L)	Watts / Lumens	Color Options (X100 Kelvins)	SPECIAL PRICE
HSLPUF22LS24W1800LDMV40K	17" x 26.5"	24 / 1800	30, 35, 40, 50	CALL
HSLPUF22LH36W2900LDMV40K	17" x 26.5"	36 / 2900	30, 35, 40, 50	CALL
HSLPUF424LS32W2600LDMV40K	26.5" x 26.5"	32 / 2600	30, 35, 40, 50	CALL
HSLPUF424LS48W3500LDMV40K	26.5" x 26.5"	48 / 3500	30, 35, 40, 50	CALL
HSLPUF248LS32W2600LDMV40K	11" x 48"	32 / 2600	30, 35, 40, 50	CALL
HSLPUF248LS48W3500LDMV40K	11" x 48"	48 / 3500	30, 35, 40, 50	CALL
HSLPUF248LS57W4200LDMV40K	11" x 48"	57 / 4200	30, 35, 40, 50	CALL
HSLPUF248LH72W5400LDMV40K	11" x 48"	72 / 5400	30, 35, 40, 50	CALL
HSLPUF448LS65W5200LDMV40K	17" x 48"	65 / 5200	30, 35, 40, 50	CALL
HSLPUF448LS97W7000LDMV40K	17" x 48"	97 / 7000	30, 35, 40, 50	CALL
HSLPUF448LS114W8400LDMV40K	17" x 48"	114 / 8400	For 30, 35, 40, 50	CALL

Emergency, add EM for \$115. Available in 3000K, 3500K and 5000K.

## LED SPILL RING



Most linear fixture are dimmable 0-10V.

ITEM NO.	DESCRIPTION	SPECIAL PRICE
HSLFL48LS32W3450LDMV40KSN	11.75"W x 48"L x 4.5"H, 3450lm - 4000K - 0-10V dimmable	CALL
HSLFL48LS48W4800LDMV40KSN	11.75"W x 48"L x 4.5"H, 4800lm - 4000K - 0-10V dimmable	CALL
HSLFL48LS57W5400LDMV40KSN	11.75"W x 48"L x 4.5"H, 5400lm - 4000K - 0-10V dimmable	CALL
HSLFL48LH72W7000LDMV40KSN	11.75"W x 48"L x 4.5"H, 7000lm - 4000K - 0-10V dimmable	CALL

Consult for Bronze. For Emergency, add EM for \$115. Available in 3000K, 3500K and 5000K.

## LED CROWN



ITEM NO.	DESCRIPTION	SPECIAL PRICE
HSLCRWNMW22LS24W2400LDMV40KWH	CROWN 25"W x 25"L x 4.125"H, 2400lm - 4000K - 0-10V dimmable	CALL
HSLCRWNMW22LS28W2700LDMV40KWH	CROWN 25"W x 25"L x 4.125"H, 2700lm - 4000K - 0-10V dimmable	CALL
HSLCRWNMW22LS35W3200LDMV40KWH	CROWN 25"W x 25"L x 4.125"H, 3200lm - 4000K - 0-10V dimmable	CALL
HSLCRWNMW14LS48W4800LDMV40KWH	CROWN 11.5"W x 48"L x 4.125"H, 4800lm - 4000K - 0-10V dimmable	CALL
HSLCRWNMW14LS57W5700LDMV40KWH	CROWN 11.5"W x 48"L x 4.125"H, 5700lm - 4000K - 0-10V dimmable	CALL
HSLCRWNMW14LH72W7000LDMV40KWH	CROWN 11.5"W x 48"L x 4.125"H, 7000lm - 4000K - 0-10V dimmable	CALL
HSLCRWNMW24LS48W4800LDMV40KWH	CROWN 16.27"W x 48"L x 4.125"H, 4800lm - 4000K - 0-10V dimmable	CALL
HSLCRWNMW24LS57W5700LDMV40KWH	CROWN 16.27"W x 48"L x 4.125"H, 5700lm - 4000K - 0-10V dimmable	CALL
HSLCRWNMW24LH72W7000LDMV40KWH	CROWN 16.27"W x 48"L x 4.125"H, 7000lm - 4000K - 0-10V dimmable	CALL

Finishes: WH - White, GO - Golden Oak, UF - Unfinished  
Available in 3000K, 3500K, 4000K and 5000K.

## LED SPILL RING BATH



ITEM NO.	DESCRIPTION	SPECIAL PRICE
HSLHOTBD24L23W2195LMVSN30K	24.5"L x 5.7"W x 4.5"E 23W, 2195 Lumens 3000K, Multi-Volt Satin Nickel	CALL
HSLHOTBD36L34W3260LMVSN30K	36.5"L x 5.7"W x 4.5"E 34W, 3261 Lumens 3000K, Multi-Volt Satin Nickel	CALL
HSLHOTBD48L48W4590LMVSN30K	48.5"L x 5.7"W x 4.5"E 48W, 4594 Lumens 3000K, Multi-Volt Satin Nickel	CALL

Consult for Bronze ends. Also available in 40K.

## VAN SERIES



ITEM NO.	DESCRIPTION	SPECIAL PRICE
HSLVAN24LS24W2250LDMV40KSW	4.75" x 4.00" x 24.125" / 24W, 2250L, 4000K	CALL
HSLVAN24LS28W2550LDMV40KSW	4.75" x 4.00" x 24.125" / 28W, 2550L, 4000K	CALL
HSLVAN48LS32W3250LDMV40KSW	4.75" x 4.00" x 48.125" / 32W, 3250L, 4000K	CALL
HSLVAN48LS48W4500LDMV40KSW	4.75" x 4.00" x 48.125" / 48W, 4500L, 4000K	CALL
HSLVAN48LS57W5100LDMV40KSW	4.75" x 4.00" x 48.125" / 57W, 5100L, 4000K	CALL

Change SW to BM (Black Marble), IV (Ivory Marble), etc for end cap in different finish See specificatio for more end cap choices. Available in 3000K, 3500K and 4000K.

Add after VAN, WR for White Ribbed, CR - Clear Ribbed, FR - For Frosted Ribbed.

## WALL PUFF SERIES



ITEM NO.	DESCRIPTION	SPECIAL PRICE
HSLWPU24LS24W2250LDMV40K	27" x 6" x 2.75" 24 Watt, 2250 Lumens, Available in 3000K, 3500K, 5000K	CALL
HSLWPU48LS48W4500LDMV40K	51" x 6" x 2.75" 48 Watt, 4500 Lumens, Available in 3000K, 3500K, 5000K	CALL

For Emergency, add EM for \$115.

## LED SPILL RING CLOSE-TO-CEILING



ITEM NO.	DESCRIPTION	SPECIAL PRICE
HSLHOTCD10L18W1300LD120SN30K	11.8"D x 4.2"H 18W, 1300 Lumens, 3000K, Multi-Volt Satin Nickel	CALL
HSLHOTCD12L17W1200LD120SN30K	11.8"D x 4.2"H 17W, 1200 Lumens, 3000K, Multi-Volt Satin Nickel	CALL
HSLHOTCD16L30W2600LMVSN30K	16"D x 4.9"H 28W, 2050 Lumens, 3000K, Multi-Volt Satin Nickel	CALL

For 4000K change 30K to 40K





### CTC 11" TWIST LOCK BRUSHED NICKEL LED 120V (DIMMABLE)

ITEM NO.	DESCRIPTION	SPECIAL PRICE
HSLHTCA11L15W800LD12040KBN	11" Brushed Nickel/Frosted Glass 15W, 800L, 4000K, Dimmable 120V, 50000 Hrs	CALL

Change 40K to 30K or 50K. While quantities last.



### CTC 11" & 14" SLEEK BRUSHED NICKEL LED 120V (DIMMABLE)

ITEM NO.	DESCRIPTION	SPECIAL PRICE
HSLHTCB11L15W900LD12040KBN	11" Brushed Nickel/Polycarbonate Diffuser 15W, 900L 4000K, Dimmable 120V, 50000 Hrs	CALL
HSLHTCB14L25W1200LD12040KBN	14" Brushed Nickel/Polycarbonate Diffuser 25W, 1200L 4000K, Dimmable 120V, 50000 Hrs	CALL

Change 40K to 30K or 50K. While quantities last.



### CTC 11" & 14" MUSHROOM LED 120V (DIMMABLE)

ITEM NO.	DESCRIPTION	SPECIAL PRICE
HSLMUS11L15W1000LD12040K	11" Mushroom White/Polycarbonate Diffuser 15W, 1000L 4000K, Dimmable 120V, 50000 Hrs	CALL
HSLMUS14L25W1600LD12040K	14" Mushroom White/Polycarbonate Diffuser 25W, 1600L 4000K, Dimmable 120V, 50000 Hrs	CALL

Change 40K to 30K or 50K. While quantities last.

### LED DRUM FIXTURE



ITEM NO.	DESCRIPTION	SPECIAL PRICE
HSLCIRDC11L13W900LD12030K	11" Drum 13W 900 Lumens, Dimmable 120V 3000K	CALL
HSLCIRDC11L14W1350LD12030K	11" Drum 14W 1350 Lumens, Dimmable 120V 3000K	CALL
HSLCIRDC14L14W1350LD12030K	14" Drum 14W 1350 Lumens, Dimmable 120V 3000K	CALL
HSLCIRDC14L23W1850LD12030K	14" Drum 23W 1850 Lumens, Dimmable 120V 3000K	CALL

Consult for multi-volt and other wattage and lumen options.

### LED MUSHROOM FIXTURE



ITEM NO.	DESCRIPTION	SPECIAL PRICE
HSLTFC11L13W900LD12030K	11" Mushroom 13W 900 Lumens, Dimmable 120V 3000K	CALL
HSLTFC11L14W1350LD12030K	11" Mushroom 14W 1350 Lumens, Dimmable 120V 3000K	CALL
HSLTFC14L14W1350LD12030K	14" Mushroom 14W 1350 Lumens, Dimmable 120V 3000K	CALL
HSLTFC14L23W1850LD12030K	14" Mushroom 23W 1850 Lumens, Dimmable 120V 3000K	CALL

Change 30K to 40K for 4000K. Consult for multi-volt and other wattage and lumen options.

## LED DOME FIXTURE



ITEM NO.	DESCRIPTION	SPECIAL PRICE
HSLHOTCE11L13W900LD12030K	11" Dome 13W 900 Lumens, Dimmable 120V 3000K	CALL
HSLHOTCE11L14W1350LD12030K	11" Dome 14W 1350 Lumens, Dimmable 120V 3000K	CALL
HSLHOTCE14L14W1350LD12030K	14" Dome 14W 1350 Lumens, Dimmable 120V 3000K	CALL
HSLHOTCE14L23W1850LD12030K	14" Dome 23W 1850 Lumens, Dimmable 120V 3000K	CALL

Change 30K to 40K for 4000K. Consult for multi-volt and other wattage and lumen options.

## ULTRA THIN FAUX DOWNLIGHT (WET LOCATION)

Choose either a round or square silhouette in two sizes and two finishes, white and brushed nickel with a special regressed lens to provide even, comfortable illumination from these edge-lit fixtures. Wet location for indoor and outdoor use. 120V only. Dims to 10% with standard dimmers.



ITEM NO.	DESCRIPTION	SPECIAL PRICE
HSLRCS5L10W660L30KWH	Square 6.3 inches Diagonal, 10W, 660 Lumens, 3000K, 120V, White	CALL
HSLRCS5L10W660L30KBN	Square 6.3 inches Diagonal, 10W, 660 Lumens, 3000K 120V, Brushed Nickel	CALL
HSLRCS7L15W1000L30KWH	Square 8.0 inches Diagonal, 15W, 1000 Lumens, 3000K, 120V, White	CALL
HSLRCS7L15W1000L30KBN	Square 8.0 inches Diagonal, 15W, 1000 Lumens, 3000K, 120V, Brushed Nickel	CALL
HSLRCR5L10W660L30KWH	Round, 5.5 inches Diameter, 10W, 660 Lumens, 3000K, 120V White	CALL
HSLRCR5L10W660L30KBN	Round, 5.5 inches Diameter, 10W, 660 Lumens, 3000K, 120V Brushed Nickel	CALL
HSLRCR7L15W1000L30KWH	Round, 7.0 inches Diameter, 15W, 1000 Lumens, 3000K, 120V White	CALL
HSLRCR7L15W1000L30KBN	Round, 7.0 inches Diameter, 15W, 1000 Lumens, 3000K, 120V Brushed Nickel	CALL

Lumens shown are gross lumens. Net lumens is 20% less.

## MICRO LED SURFACE MOUNT (WET LOCATION)



ITEM NO.	DESCRIPTION	SPECIAL PRICE
HLSMC4L12W900L30KWH	4" (5.9" OD ) White, 12W 876L, CRI > 80, 3000K, 120V, with 20W Dimmable Driver. Surface Mount.	CALL
HLSMC6L15W1100L30KWH	6" (7.4" OD ) White, 15W 1095L, CRI > 80, 3000K, 120V, Dimmable Driver. Surface Mount.	CALL
HLSMC9L26W2100L30KWH	9" Diameter, 26W, 2100 Lumen, 30K in White Dimmable Driver, Surface Mount	CALL
HLSMC4RECACC	Recessed Accessory Kit to Retro SMC4L Series into 4" Recessed White Can Housings	CALL
HLSMC6RECACC	Recessed Accessory Kit to Retro SMC6L Series into 6" Recessed White Can Housings	CALL

Consult for bronze and satin nickel. Also available in 9 inch version - 26 watt.

## SMC EMERGENCY AND 277V VERSION



ITEM NO.	DESCRIPTION	SPECIAL PRICE
HLSMC6L15W1100L30KWH-277V	Surface Disc in 277V 15W, 1100L, 30K in White	CALL
HLSMC6L15W1100L30KWH-EM	Surface Disc with Integral Emergency Back-Up in recessed junction Box; 15W 1100L; EM mode 6w 400L 3000K White	CALL

Emergency version comes with junction box.

## MICRO ECONOMY LED SURFACE MOUNT



ITEM NO.	DESCRIPTION	SPECIAL PRICE
HSLLM6L15W1100LD12030KWH	Surface Mount LED 15W 1100L, Dimmable. 35000 Hours. 7.4"OD x 1.26"H, White	CALL
HSLLM6L15W1100LD12030KBA	Surface Mount LED 15W 1100L, Dimmable. 35000 Hours. 7.4"OD x 1.26"H, Brushed Aluminum	CALL

## SURFACE DISCS 11" AND 15"



ITEM NO.	DESCRIPTION	SPECIAL PRICE
HSLSMC11L28W1700LD12030KBN	SURFACE Disc 11" Dia LED 28W 1700 lumen BN	CALL
HSLSMC11L28W1700LD12030KWH	SURFACE Disc 11" Dia LED 28W 1700 lumen WH	CALL
HSLSMC15L40W2500LD12030KBN	SURFACE Disc 15" Dia LED 40W 2500 lumen BN	CALL
HSLSMC15L40W2500LD12030KWH	SURFACE Disc 15" Dia LED 40W 2500 lumen WH	CALL



## STYLISH AND REALLY ECONOMICAL LED DISK, IDEAL FOR C-T-C

ITEM NO.	DESCRIPTION	SPECIAL PRICE
HSLTDL6L15W1100L30KWH	7 3/8"D x 1 1/2"H DISK LIGHT 15W/1100 Lumen 120V AC 3000K WHITE	CALL
HSLTDL6L15W1100L30KBA	7 3/8"D x 1 1/2"H DISK LIGHT 15W/1100 Lumen 120V AC 3000K BRUSHED ALUMINUM	CALL
HSLTDL6L15W1100L30KBZ	7 3/8"D x 1 1/2"H DISK LIGHT 15W/1100 Lumen 120V AC 3000K BRONZE	CALL
HSLTDL6RECACC	Recessed Accessory Kit for TDLG	CALL

Change 30K to 40K.

## CTC / WALL FIXTURE RETROFITS (AC WITH DRIVER ON BOARD AND HEAT SINK)



ITEM NO.	DESCRIPTION	SPECIAL PRICE
HSLEOS12W900LD12030KSQ	EOS Array w/6" Sq Alum Heat Sink - 12W, 900L, 3000K	CALL
HSLEOS12W1000LD12040KSQ	EOS Array w/6" Sq Alum Heat Sink - 12W, 1000L, 4000K	CALL
HSLEOS15W1350LD12030KSQ	EOS Array w/8" Sq Alum Heat Sink - 15W, 1350L, 3000K	CALL
HSLEOS15W1400LD12040KSQ	EOS Array w/8" Sq Alum Heat Sink - 15W, 1400L, 4000K	CALL
HSLEOS22W1850LD12030KSQ	EOS Array w/8" Sq Alum Heat Sink - 22W, 1850L, 3000K	CALL
HSLEOS22W1900LD12040KSQ	EOS Array w/8" Sq Alum Heat Sink - 22W, 1900L, 4000K	CALL

Dimmable with standard dimmer. UL Classified for retrofit

## CTC RETROFIT FOR 11" OR 14" WITH HEAT SINK (DIMMABLE W/STANDARD DIMMER)



ITEM NO.	DESCRIPTION	SPECIAL PRICE
HSLDAC15W1350LD12040K	LED Array 120V for 11" CTC 15W, 1350L / Color Temp 30, 40, 50	CALL
HSLDAC25W1850LD12030K	LED Array 120V for 14" CTC 25W, 1850L / Color Temp 30, 40, 50	CALL

Also available in 50K





Peace of Mind  
with **QUIK**  
LED  
Change With the  
Times

# THE SIMPLE LED SOLUTION : LITE fixtures with Savegreen Lamps



Available in 35K, 40K and 50K

Version	Code	Item No.	(Replace 40K w/35K or 50K)	Description
<b>Bypass Single Ended</b>				
Popular	SGB15W35	LT8BG48L15W1740L40K		Frosted Glass Single Ended Bypass T8 Lamp 48 Inch 15W 1740 Lumens 4000K
Standard	SGS29W40	LT8BGC24L9W1050L40K		Plastic Coated Glass Single Ended Bypass T8 Lamp 24 Inch 9W 1050 Lumens 4000K
Standard	SGS312W40	LT8BGC36L12W1200L40K		Plastic Coated Glass Single Ended Bypass T8 Lamp 36 Inch 12W 1200 Lumens 4000K
Standard	SGS15W40	LT8BGC48L15W1740L40K		Plastic Coated Glass Single Ended Bypass T8 Lamp 48 Inch 15W 1740 Lumens 4000K
Premium	SGP12W40	L10T8BGC48L12W1750L40K		Premium Single Ended Bypass T8 Lamp Plastic Coated Glass 48 Inch 12W 1750 Lumens 4000K
Premium	SGP15W40	L10T8BGC48L15W1750L40K		Premium Single Ended Bypass T8 Lamp Plastic Coated Glass 48 Inch 15W 2000 Lumens 4000K
Premium	SGP18W40	L10T8BGC48L18W2500L40K		Premium Single Ended Bypass T8 Lamp Plastic Coated Glass 48 Inch 18W 2500 Lumens 4000K
High Output	SGH26W40	LT8BGC48L26W3500L40K		High Output Singed Ended Bypass T8 Lamp Plastic Coated Glass 48 Inch 26W 3500 Lumens 4000K
T5HO	SGT525W40	LT5BG46L25W3300L40K		Frosted Glass T5HO Single Ended Bypass T5 Lamp 46 Inch 25W 3300 Lumens 4000K
<b>Bypass Double Ended or Single Ended</b>				
Popular	SGD18W40	LT8BDGC48L18W2100L40K		Double & Single Ended Bypass T8 Lamps Plastic Coated Glass 48 Inch 18W 2100 Lumens 4000K
Premium	SGPD12W40	L10T8BDGC48L12W1750L40K		Premium Double & Single Ended Bypass T8 Lamps Plastic Coated Glass 48 Inch 12W 1750 Lumens 4000K
Premium	SGPD18W40	L10T8BDGC48L18W2500L40K		Premium Double & Single Ended Bypass T8 Lamps Plastic Coated Glass 48 Inch 18W 2500 Lumens 4000K
<b>Magic - Type A and Type B</b>				
Magic	SGM18W40K	LT8ABP48L18W2250L40K		Type A & B Plastic T8 Lamp Single Ended 48 Inch 18W 2250 Lumens 4000K
Magic	SGM15W40K	LT8ABP48L15W1875L40K		Type A & B Plastic T8 Lamp Single Ended 48 Inch 15W 1875 Lumens 4000K
Magic	SGM215W40K	LT8ABP24L15W1875L40K		Type A & B Plastic T8 Lamp Single Ended 24 Inch 15W 1875 Lumens 4000K
<b>Dimming - Bypass Single Ended &amp; - Type C (Driver &amp; Tubes)</b>				
Dimming	**	LD2T8BGC48L18W2200L40K		2 Wire Dimming Plastic Coated Glass Single Ended Bypass T8 Lamps 48 Inch 18W 2200 Lumens 4000K
Type C	**	JIGZYT810W600BOT40K		LED T8 DIM 2FT 10W 1200 Lumens 4000K

## How To Add Emergency to QUIKLED



Separate LED Array added for Emergency.



### KEYSTONE KT-EMERG-LED-12-1200-K1 LED EMERGENCY LIGHTING KIT

**12W Constant Wattage - Ballast Battery Backup - Damp Location - 120- 277V**  
Includes driver, separately housed 1200mAh Ni-Cd battery and 0.7" x 8" 1200 Lumen LED module for complete emergency lighting installations. When AC power fails, the driver will power the LED for a minimum of 90 minutes emergency illumination. Easy installation in existing LED or fluorescent fixtures with wiring diagrams and labels on all parts. Mounting hardware included. Full 5 year warranty on all components.

Output Current 1000 mA-200mA - Output Voltage 12 ~41 Vdc

**To order, ADD: EMKT12 to end of X1LED item number and ADD \$100 to the fixture price for the EM. EM will be installed.**

## How To Add an Inverter to QUIKLED



**KT-EMRG-LED-5-500-AC**  
CONSTANT WATTAGE LED EMERGENCY BACK-UP

### DESCRIPTION

LED Emergency Back-Up Driver | Standard Side Exit Wire Leads | 5W Output

**DRIVER TYPE:** Constant Wattage LED Emergency

**MAX. OUTPUT POWER:** 5W

**INPUT VOLTAGE:** 120-277Vac ±10%

**OUTPUT VOLTAGE:** 40-300Vdc

**OUTPUT CURRENT:** Load Dependant

**WARRANTY:** 5 Years

### PRODUCT FEATURES

- Optimized for Keystone Single Ended Direct Drive LED tube
- Contact Keystone for details on functioning with other Type B LED tubes
- Illuminates entire LED load at reduced output under emergency mod
- One Piece Design with Metal Housin
- 2 -in- 1 LED test switch and indicator light include
- Evaluated to UL 924 requirement

**To order, ADD: INV5 to end of X1LED item number and ADD \$79 to the fixture price for the Inverter.**

## PARABOLIC



ITEM NO.	DESCRIPTION	SPECIAL PRICE
HSLPARA8C23212X1LN18W40	1x4 4200 Lumen Parabolic 8C w/2x18W LED T8 4000K Lamps included	CALL
HSLPARA9C217X1LN15W40	2x2 3750 Lumen Parabolic 9C w/2x15W LED T8 4000K Lamps included	CALL
HSLPARA9C317X1LN15W40	2x2 5625 Lumen Parabolic 9C w/3x15W LED T8 4000K Lamps included	CALL
HSLPARA9C417X1LN15W40	2x2 7500 Lumen Parabolic 9C w/4x15W LED T8 4000K Lamps included	CALL
HSLPARA12C232X1LN18W40	2x4 4200 Lumen Parabolic 12C w/2x18W LED T8 4000K Lamps included	CALL
HSLPARA18C232X1LN18W40	2x4 4200 Lumen Parabolic 18C w/2x18W LED T8 4000K Lamps included	CALL
HSLPARA18C332X1LN18W40	2x4 6300 Lumen Parabolic 18C w/3x18W LED T8 4000K Lamps included	CALL
HSLPARA18C432X1LN18W40	2x4 8400 Lumen Parabolic 18C w/4x18W LED T8 4000K Lamps included	CALL
HSLPARA32C432X1LN18W40	2x4 8400 Lumen Parabolic 32C w/4x18W LED T8 4000K Lamps included	CALL

Change 40 to 35 or 50 for different Kelvin. Change Lamp Wattage to 15W on 2FT or 15W on 4FT

## SHALLOW, HIGH EFFICIENT PARABOLIC



ITEM NO.	DESCRIPTION	SPECIAL PRICE
HSLPES9C217X1LN15W40	2x2 3750 Lumen Parabolic 9C w/2x15W LED T8 4000K Lamps Included	CALL
HSLPES9C317X1LN15W40	2x2 5625 Lumen Parabolic 9C w/3x15W LED T8 4000K Lamps Included	CALL
HSLPES9C417X1LN15W40	2x2 7500 Lumen Parabolic 9C w/4x15W LED T8 4000K Lamps Included	CALL
HSLPES12C232X1LN18W40	2x4 4200 Lumen Parabolic 12C w/2x18W LED T8 4000K Lamps Included	CALL
HSLPES18C232X1LN18W40	2x4 4200 Lumen Parabolic 18C w/2x18W LED T8 4000K Lamps Included	CALL
HSLPES18C332X1LN18W40	2x4 6300 Lumen Parabolic 18C w/3x18W LED T8 4000K Lamps Included	CALL
HSLPES18C432X1LN18W40	2x4 8400 Lumen Parabolic 18C w/4x18W LED T8 4000K Lamps Included	CALL

Change 40 to 35 or 50 for different Kelvin. Change Lamp Wattage to 15W on 2FT or 15W on 4FT  
Change PES to PEW for White Louver

**Frame-In-Kits Available for Recessed Fixtures to mount in hard ceilings**

**FIK 1x4 \$17.90**  
**FIK 2x2 \$24.70**  
**FIK 2x4 \$25.80**

For Emergency Option, see page K17.

**Consult for Fixtures Wired for LED T8 Lamps with Lamps Sold Separately**

**For Dimmable Version** - Change X1 to JLDMV and LN18W to LN18D  
Adder 1 Light Fixture - \$17.50; Adder 2 Light Fixture - \$19.00;  
Adder 3 Light Fixture - \$36.50; Adder 4 Light Fixture - \$38.00 Example:  
Item No. 131A432JLDMVLN18D40K 0-10V Dimming



**For Large Quantities, Call For Quote**

## TROFFER



ITEM NO.	DESCRIPTION	SPECIAL PRICE
HSL131A23212X1LN18W40	1x4 4200 Lumen Troffer w/2x18W LED T8 4000K Lamps included	CALL
HSL131A217X1LN15W40	2x2 3750 Lumen Troffer w/2x15W LED T8 4000K Lamps included	CALL
HSL131A317X1LN15W40	2x2 5625 Lumen Troffer w/3x15W LED T8 4000K Lamps included	CALL
HSL131A417X1LN15W40	2x2 7500 Lumen Troffer w/4x15W LED T8 4000K Lamps included	CALL
HSL131A232X1LN18W40	2x4 4200 Lumen Troffer w/2x18W LED T8 4000K Lamps included	CALL
HSL131A332X1LN18W40	2x4 6300 Lumen Troffer w/3x18W LED T8 4000K Lamps included	CALL
HSL131A432X1LN18W40	2x4 8400 Lumen Troffer w/4x18W LED T8 4000K Lamps included	CALL

Change 40 to 35 or 50 for different Kelvin. Change Lamp Wattage to 15W on 2FT or 15W on 4FT

## CENTER BASKET



ITEM NO.	DESCRIPTION	SPECIAL PRICE
HSLUCPF23212X1LN18W40	1x4 4200 Lumen Center Basket w/2x18W LED T8 4000K Lamps Included	CALL
HSLUCPF217X1LN15W40	2x2 3750 Lumen Center Basket w/2x15W LED T8 4000K Lamps Included	CALL
HSLUCPF317X1LN15W40	2x2 5625 Lumen Center Basket w/3x15W LED T8 4000K Lamps Included	CALL
HSLUCPF232X1LN18W40	2x4 4200 Lumen Center Basket w/2x18W LED T8 4000K Lamps Included	CALL
HSLUCPF332X1LN18W40	2x4 6300 Lumen Center Basket w/3x18W LED T8 4000K Lamps Included	CALL

Change 40 to 35 or 50 for different Kelvin. Change Lamp Wattage to 15W on 2FT or 15W on 4FT  
Change PF to LL for Linear Ribbed Lens

## DUAL BASKET



ITEM NO.	DESCRIPTION	SPECIAL PRICE
HSLUDPF217X1LN15W40	2x2 3750 Lumen Troffer w/2x15W LED T8 4000K Lamps Included	CALL
HSLUDPF232X1LN18W40	2x4 4200 Lumen Dual Basket w/2x18W LED T8 4000K Lamps Included	CALL

Change 40 to 35 or 50 for different Kelvin. Change Lamp Wattage to 15W on 2FT or 15W on 4FT  
Change PF to LL for Linear Ribbed Lens

## DEEP CENTER BASKET



ITEM NO.	DESCRIPTION	SPECIAL PRICE
HSLRDI217X1LN15W40	2x2 3750 Lumen Center Basket w/2x15W LED T8 4000K Lamps Included	CALL
HSLRDI317X1LN15W40	2x2 5625 Lumen Center Basket w/3x15W LED T8 4000K Lamps Included	CALL
HSLRDI232X1LN18W40	2x4 4200 Lumen Center Basket w/2x18W LED T8 4000K Lamps Included	CALL
HSLRDI332X1LN18W40	2x4 6300 Lumen Center Basket w/3x18W LED T8 4000K Lamps Included	CALL

Change 40 to 35 or 50 for different Kelvin. Change Lamp Wattage to 13W on 2FT or 15W on 4FT

**For Dimmable Version** - Change X1 to JLDMV and LN18W to LN18D  
Adder 1 Light Fixture - \$17.50; Adder 2 Light Fixture - \$19.00;  
Adder 3 Light Fixture - \$36.50; Adder 4 Light Fixture - \$38.00 Example:  
Item No. 131A432JLDMLN18D40K 0-10V Dimming



For Emergency Option, see page K17.

**For Large Quantities, Call For Quote**

## 4X4 RECESSED LINEAR (FOR T-BAR CEILING)

ITEM NO.	DESCRIPTION	SPECIAL PRICE
HSL44RSF117X1WHLN15W40K	4" x 24" 1875 Lumen Recessed TBAR 1x 15W LED T8 4000K Lamps Included	CALL
HSL44RSF217X1WHLN15W40K	4" x 24" 3750 Lumen Recessed TBAR 2x 15W LED T8 4000K Lamps Included	CALL
HSL44RSF132X1WHLN18W40K	4" x 48" 2100 Lumen Recessed TBAR 1x 18W LED T8 4000K Lamps Included	CALL
HSL44RSF232X1WHLN18W40K	4" x 48" 4200 Lumen Recessed TBAR 2x 18W LED T8 4000K Lamps Included	CALL
HSL44RSF1328X1WHLN18W40K	4" x 96" 4200 Lumen Recessed TBAR 2x 18W LED T8 4000K Lamps Included	CALL
HSL44RSF2328X1WHLN18W40K	4" x 96" 8400 Lumen Recessed TBAR 4x 18W LED T8 4000K Lamps Included	CALL

Change 40 to 35 or 50 for different Kelvin. Change Lamp Wattage to 15W on 2FT or 15W on 4FT  
 Change SF (Snap Fit Frosted Lens) to MW for Matte White Regressed Lens  
 Change 44R to 44RF for Recessed Flanged or 44RRXX for Recessed Flangeless for XX" sheetrock depth.  
 For Baffled Louve , change MW to BL and add \$10 per 4FT.

## 6X6 RECESSED LINEAR (FOR T-BAR CEILING)

ITEM NO.	DESCRIPTION	SPECIAL PRICE
HSL66RMW117X1WHLN15W40K	6" x 26" 1875 Lumen Recessed TBAR 1x 15W LED T8 4000K Lamps Included	CALL
HSL66RMW217X1WHLN15W40K	6" x 26" 3750 Lumen Recessed TBAR 2x 15W LED T8 4000K Lamps Included	CALL
HSL66RMW132X1WHLN18W40K	6" x 48" 2100 Lumen Recessed TBAR 1x 18W LED T8 4000K Lamps Included	CALL
HSL66RMW232X1WHLN18W40K	6" x 48" 4200 Lumen Recessed TBAR 2x 18W LED T8 4000K Lamps Included	CALL
HSL66RMW1328X1WHLN18W40K	6" x 96" 4200 Lumen Recessed TBAR 2x 18W LED T8 4000K Lamps Included	CALL
HSL66RMW2328X1WHLN18W40K	6" x 96" 8400 Lumen Recessed TBAR 4x 18W LED T8 4000K Lamps Included	CALL

Change 40 to 35 or 50 for different Kelvin. Change Lamp Wattage to 15W on 2FT or 15W on 4FT  
 Change 66R to 66RF for Recessed Flanged or 66RRXX for Recessed Flangeless for XX" sheetrock depth.  
 For Baffled Louve , change MW to BL and add \$10 per 4FT.

## 2.5 RECESSED LINEAR (FLANGED FOR HARD CEILINGS)

ITEM NO.	DESCRIPTION	SPECIAL PRICE
HLSSES25RFSF117X1WHLN15W40K	4"x24" 1875 Lumen Recessed 2.5" Flanged 1x15W LED T8 4000K Lamps Included	CALL
HLSSES25RFSF132X1WHLN18W40K	4"x48" 2100 Lumen Recessed 2.5" Flanged 1x18W LED T8 4000K Lamps Included	CALL
HLSSES25RFSF1328X1WHLN18W40K	4"x96" 4200 Lumen Recessed 2.5" Flanged 2x18W LED T8 4000K Lamps Included	CALL

Change 40 to 35 or 50 for different Kelvin. Change Lamp Wattage to 15W on 2FT or 15W on 4FT  
 Change SES25RFSF to 44R for Recessed TBAR or SES25RRXX for Recessed Flangeless for XX" sheetrock depth.



Special red sockets to identify fixtures made for LED T8 lamps.



Shown with Flange  
SES25RFSF

**For Dimmable Version** - Change X1 to JLDMV and LN18W to LN18D  
 Adder 1 Light Fixture - \$17.50; Adder 2 Light Fixture - \$19.00;  
 Adder 3 Light Fixture - \$36.50; Adder 4 Light Fixture - \$38.00  
 Example: Item No. 131A432JLDMVLN18D40K 0-10V Dimming



For Large Quantities, Call For Quote



## PLIN LOUVER BLADE LINEAR PENDANT



ITEM NO.	DESCRIPTION	SPECIAL PRICE
HSLPLIN232X1WHLN18W40-HC401WH	48" PLIN 90% DOWN 4200 Lumen 2x18W LED T8 4000K Lamps included w/5 ft cable kit	CALL
HSLPLIN2328X1WHLN18W40-HC401WH	96" PLIN 90% DOWN 8400 Lumen 4x18W LED T8 4000K Lamps included w/5 ft cable kit	CALL

Change 40 to 35 or 50 for different Kelvin. Change Lamp Wattage to 15W on 4FT.  
Change WH TO BK (Black), RD (Red), IR (Iron), SL (Silver) or BR (Bronze) add \$30 for 48" and \$50 for 96"

## 4X4 LINEAR PENDANT



ITEM NO.	DESCRIPTION	SPECIAL PRICE
HSL44PSF117X1WHLN15W40-HC301WH	4" x 24" 1875 Lumen Pendant w/Cable Kit 1x15W LED T8 4000K Lamps Included	CALL
HSL44PSF217X1WHLN15W40-HC301WH	4" x 24" 3750 Lumen Pendant w/Cable Kit 2x15W LED T8 4000K Lamps Included	CALL
HSL44PSF132X1WHLN18W40-HC301WH	4" x 48" 2100 Lumen Pendant w/Cable Kit 1x18W LED T8 4000K Lamps Included	CALL
HSL44PSF232X1WHLN18W40-HC301WH	4" x 48" 4200 Lumen Pendant w/Cable Kit 2x18W LED T8 4000K Lamps Included	CALL
HSL44PSF1328X1WHLN18W40-HC301WH	4" x 96" 4200 Lumen Pendant w/Cable Kit 2x18W LED T8 4000K Lamps Included	CALL
HSL44PSF2328X1WHLN18W40-HC301WH	4" x 96" 8400 Lumen Pendant w/Cable Kit 4x18W LED T8 4000K Lamps Included	CALL

Change 40 to 35 or 50 for different Kelvin. Change Lamp Wattage to 15W on 2FT or 15W on 4FT  
Change SF (Snap Fit Frosted Lens) to MW for Matte White Regressed Lens  
Change HC301WH to HC302WH for 10" Cable Kit plus \$5.00  
Change WH to BK (Black), IR (Iron), SL (Silver) or BR (Bronze) add \$30 for 48" and \$50 for 96"  
For surface mount, remove HC301WH and deduct \$19.00

## 6X6 LINEAR PENDANT



ITEM NO.	DESCRIPTION	SPECIAL PRICE
HSL66PMW117X1WHLN15W40-HC301WH	6" x 26" 1875 Lumen Pendant w/Cable Kit 1x15W LED T8 4000K Lamps Included	CALL
HSL66PMW217X1WHLN15W40-HC301WH	6" x 26" 3750 Lumen Pendant w/Cable Kit 2x15W LED T8 4000K Lamps Included	CALL
HSL66PMW132X1WHLN15W40-HC301WH	6" x 48" 2100 Lumen Pendant w/Cable Kit 1x18W LED T8 4000K Lamps Included	CALL
HSL66PMW232X1WHLN15W40-HC301WH	6" x 48" 4200 Lumen Pendant w/Cable Kit 2x18W LED T8 4000K Lamps Included	CALL
HSL66PMW1328X1WHLN15W40-HC301WH	6" x 96" 4200 Lumen Pendant w/Cable Kit 2x18W LED T8 4000K Lamps Included	CALL
HSL66PMW2328X1WHLN15W40-HC301WH	6" x 96" 8400 Lumen Pendant w/Cable Kit 4x18W LED T8 4000K Lamps Included	CALL

Change 40 to 35 or 50 for different Kelvin. Change Lamp Wattage to 15W on 2FT or 15W on 4FT  
Change HC301WH to HC302WH for 10" Cable Kit plus \$5.00  
Change WH to BK (Black), IR (Iron), SL (Silver) or BR (Bronze) add \$30 for 48" and \$50 for 96"  
For surface mount, remove HC301WH and deduct \$19.00  
For Baffled Louve , change MW to BL and add \$10 per 4FT.

**For Dimmable Version** - Change X1 to JLDMMV and LN18W to LN18D  
Adder 1 Light Fixture - \$17.50; Adder 2 Light Fixture - \$19.00;  
Adder 3 Light Fixture - \$36.50; Adder 4 Light Fixture - \$38.00  
Example: Item No. 131A432JLDMMV LN18D40K 0-10V Dimming



**For Large Quantities, Call For Quote**

# LINEAR PENDANT

## LED T8 PENDANT (SUSPENDED ONLY - COMES W/ PENDANT)



ITEM NO.	DESCRIPTION	SPECIAL PRICE
HSLLTXTX132X1CHLN18W40K	48" Linear Pendant 2100 Lumens 1x18W LED T8 Chrome	CALL
HSLLTXTX132X1WHLN18W40K	48" Linear Pendant 2100 Lumens 1x18W LED T8 White	CALL

Comes with 5ft Cable Kit. Available in 3500K and 5000K.

## LOUVERED 8" DECORATIVE LINEAR



Shown in Black (BK).

ITEM NO.	DESCRIPTION	SPECIAL PRICE
HSLLVSTX232X1WHLN18W40-HC301WH	48" LVS WHITE 4200 Lumen 2x18W LED T8 4000K Lamps included w/5 ft cable kit	CALL
HSLLVSTX2328X1WHLN18W40-HC401WH	96" LVS WHITE 8400 Lumen 4x18W LED T8 4000K Lamps included w/5 ft cable kit	CALL

Change 40 to 35 or 50 for different Kelvin. Change Lamp Wattage to 15W on 2FT or 15W on 4FT  
Change WH TO BK (Black), IR (Iron), SL (Silver) or BR (Bronze) add \$30 for 48" and \$50 for 96"

## LOUVERED 6" DECORATIVE LINEAR



ITEM NO.	DESCRIPTION	SPECIAL PRICE
HSLLVSTX6232X1WHLN18W40-HC301WH	48" LVS WHITE 4200 Lumen 2x18W LED T8 4000K Lamps included w/5 ft cable kit	CALL
HSLLVSTX62328X1WHLN18W40-HC401WH	96" LVS WHITE 8400 Lumen 4x18W LED T8 4000K Lamps included w/5 ft cable kit	CALL

Change 40 to 35 or 50 for different Kelvin. Change Lamp Wattage to 15W on 2FT or 15W on 4FT  
Change WH TO BK (Black), IR (Iron), SL (Silver) or BR (Bronze) add \$30 for 48" and \$50 for 96"

## 1 LIGHT 2.5 IN. ENCLOSED STRIP



Detail View

ITEM NO.	DESCRIPTION	SPECIAL PRICE
HLSSES25FR132X1LN18W40-HC301WH	2.5"x48" PENDANT or SURFACE LINEAR 2100 Lumen 1x18W LED T8 4000K Lamps included	CALL
HLSSES25FR1328X1LN18W40-HC301WH	2.5"x96" PENDANT or SURFACE LINEAR 4200 Lumen 2x18W LED T8 4000K Lamps included	CALL

Change 40 to 35 or 50 for different Kelvin. Change Lamp Wattage to 15W on 2FT or 15W on 4FT  
Change WH TO BK (Black), IR (Iron), SL (Silver) or BR (Bronze) add \$30 for 48" and \$50 for 96"

**For Dimmable Version** - Change X1 to JLDMMV and LN18W to LN18D  
Adder 1 Light Fixture - \$17.50; Adder 2 Light Fixture - \$19.00;  
Adder 3 Light Fixture - \$36.50; Adder 4 Light Fixture - \$38.00  
Example: Item No. 131A432JLDMV LN18D40K 0-10V Dimming



For Large Quantities, Call For Quote

## SURFACE TROFFER



ITEM NO.	DESCRIPTION	SPECIAL PRICE
HSL153A23212X1LN18W40	1x4 4200 Lumen Troffer w/2x18W LED T8 4000K Lamps Included	CALL
HSL153A217X1LN15W40	2x2 3750 Lumen Troffer w/2x15W LED T8 4000K Lamps Included	CALL
HSL153A317X1LN15W40	2x2 5625 Lumen Troffer w/3x15W LED T8 4000K Lamps Included	CALL
HSL153A417X1LN15W40	2x2 7500 Lumen Troffer w/4x15W LED T8 4000K Lamps Included	CALL
HSL153A232X1LN18W40	2x4 4200 Lumen Troffer w/2x18W LED T8 4000K Lamps Included	CALL
HSL153A332X1LN18W40	2x4 6300 Lumen Troffer w/3x18W LED T8 4000K Lamps Included	CALL
HSL153A432X1LN18W40	2x4 8400 Lumen Troffer w/4x18W LED T8 4000K Lamps Included	CALL

Change 40 to 35 or 50 for different Kelvin. Change Lamp Wattage to 9W on 2FT (1050L) or 15W on 4FT (1740). For Frosted Lens change A to FR and add \$9.00

## SURFACE PARABOLIC



Special red sockets to identify fixtures made for LED T8 lamps.

ITEM NO.	DESCRIPTION	SPECIAL PRICE
HSLSHPARA8C23212X1LN18W40	1x4 4200 Lumen Parabolic 8C w/2x18W LED T8 4000K Lamps Included	CALL
HSLSHPARA9C217X1LN15W40	2x2 3750 Lumen Parabolic 9C w/2x15W LED T8 4000K Lamps Included	CALL
HSLSHPARA9C317X1LN15W40	2x2 5625 Lumen Parabolic 9C w/3x15W LED T8 4000K Lamps Included	CALL
HSLSHPARA9C417X1LN15W40	2x2 7500 Lumen Parabolic 9C w/4x15W LED T8 4000K Lamps Included	CALL
HSLSHPARA12C232X1LN18W40	2x4 4200 Lumen Parabolic 12C w/2x18W LED T8 4000K Lamps Included	CALL
HSLSHPARA18C232X1LN18W40	2x4 4200 Lumen Parabolic 18C w/2x18W LED T8 4000K Lamps Included	CALL
HSLSHPARA18C332X1LN18W40	2x4 6300 Lumen Parabolic 18C w/3x18W LED T8 4000K Lamps Included	CALL
HSLSHPARA18C432X1LN18W40	2x4 8400 Lumen Parabolic 18C w/4x18W LED T8 4000K Lamps Included	CALL
HSLSHPARA32C432X1LN18W40	2x4 8400 Lumen Parabolic 32C w/4x18W LED T8 4000K Lamps Included	CALL

Change 40 to 35 or 50 for different Kelvin. Change Lamp Wattage to 9W on 2FT (1050L) or 15W on 4FT (1740).

For Emergency Option, see page K17.

**For Dimmable Version** - Change X1 to JLDMMV and LN18W to LN18D  
 Adder 1 Light Fixture - \$17.50; Adder 2 Light Fixture - \$19.00;  
 Adder 3 Light Fixture - \$36.50; Adder 4 Light Fixture - \$38.00  
 Example: Item No. 131A432JLDMMVLN18D40K 0-10V Dimming



**For Large Quantities, Call For Quote**

## SURFACE HIGH EFFICIENT PARABOLIC

ITEM NO.	DESCRIPTION	SPECIAL PRICE
HLSHPES9C217X1LN15W40	2x2 3750 Lumen Parabolic 9C w/2x15W LED T8 4000K Lamps Included	CALL
HLSHPES9C317X1LN15W40	2x2 5625 Lumen Parabolic 9C w/3x15W LED T8 4000K Lamps Included	CALL
HLSHPES9C417X1LN15W40	2x2 7500 Lumen Parabolic 9C w/4x15W LED T8 4000K Lamps Included	CALL
HLSHPES12C232X1LN18W40	2x4 4200 Lumen Parabolic 12C w/2x18W LED T8 4000K Lamps Included	CALL
HLSHPES18C232X1LN18W40	2x4 4200 Lumen Parabolic 18C w/2x18W LED T8 4000K Lamps Included	CALL
HLSHPES18C332X1LN18W40	2x4 6300 Lumen Parabolic 18C w/3x18W LED T8 4000K Lamps Included	CALL
HLSHPES18C432X1LN18W40	2x4 8400 Lumen Parabolic 18C w/4x18W LED T8 4000K Lamps Included	CALL



(Surface Mount has shroud)

Change 40 to 35 or 50 for different Kelvin. Change Lamp Wattage to 9W on 2FT (1050L) or 15W on 4FT (1740). Change PES to PEW for White Louver

## SURFACE CENTER BASKET

ITEM NO.	DESCRIPTION	SPECIAL PRICE
HLSHUCPF23212X1LN18W40	1x4 4200 Lumen Center Basket w/2x18W LED T8 4000K Lamps Included	CALL
HLSHUCPF217X1LN15W40	2x2 3750 Lumen Center Basket w/2x15W LED T8 4000K Lamps Included	CALL
HLSHUCPF317X1LN15W40	2x2 5625 Lumen Center Basket w/3x15W LED T8 4000K Lamps Included	CALL
HLSHUCPF232X1LN18W40	2x4 4200 Lumen Center Basket w/2x18W LED T8 4000K Lamps Included	CALL
HLSHUCPF332X1LN18W40	2x4 6300 Lumen Center Basket w/3x18W LED T8 4000K Lamps Included	CALL



Change 40 to 35 or 50 for different Kelvin. Change Lamp Wattage to 9W on 2FT (1050L) or 15W on 4FT (1740). Change PF to LL for Linear Ribbed Lens

**Consult for Wired for LED T8 Lamps with Lamps Sold Separately**

## SURFACE DUAL BASKET

ITEM NO.	DESCRIPTION	SPECIAL PRICE
HLSHUDPF217X1LN15W40	2x2 3750 Lumen Dual Basket w/2x15W LED T8 4000K Lamps Included	CALL
HLSHUDPF232X1LN18W40	2x4 4200 Lumen Dual Basket w/2x18W LED T8 4000K Lamps Included	CALL



Change 40 to 35 or 50 for different Kelvin. Change Lamp Wattage to 15W on 2FT or 15W on 4FT Change PF to LL for Linear Ribbed Lens

**For Dimmable Version** - Change X1 to JLDMV and LN18W to LN18D  
 Adder 1 Light Fixture - \$17.50; Adder 2 Light Fixture - \$19.00;  
 Adder 3 Light Fixture - \$36.50; Adder 4 Light Fixture - \$38.00  
 Example: Item No. 131A432JLDMVLN18D40K 0-10V Dimming



For Emergency Option, see page K17.

**For Large Quantities, Call For Quote**



## ECLIPSE



ITEM NO.	DESCRIPTION	SPECIAL PRICE
HSLECLMW217X1WHLN15W40K (TO, BM, IM, SI, WM)	9"x24" 3750 Lumen w/2x15W LED T8 4000K Lamps Included	CALL
HSLECLMW232X1WHLN18W40K (TO, BM, IM, SI, WM)	9"x48" 4200 Lumen w/2x18W LED T8 4000K Lamps Included	CALL
HSLECLMW417X1WHLN15W40K (TO, BM, IM, SI, WM)	17"x24" 7500 Lumen w/4x15W LED T8 4000K Lamps Included	CALL
HSLECLMW432X1WHLN18W40K (TO, BM, IM, SI, WM)	17"x48" 8400 Lumen w/4x18W LED T8 4000K Lamps Included	CALL

Change 40 to 35 or 50 for different Kelvin. Change Lamp Wattage to 15W on 2FT or 15W on 4FT.

## PUF SURFACE LINEAR



ITEM NO.	DESCRIPTION	SPECIAL PRICE
HSLPUF23211X1LN18W40K	11x48 inches 4200 Lumen w/2x18W LED T8 4000K Lamps Included	CALL
HSLPUF41717X1LN15W40K	17x24 inches 7500 Lumen w/4x15W LED T8 4000K Lamps Included	CALL
HSLPUF43217X1LN18W40K	17x48 inches 8400 Lumen w/4x18W LED T8 4000K Lamps Included	CALL

Change 40 to 35 or 50 for different Kelvin. Change Lamp Wattage to 15W on 4FT.

## CROWN



ITEM NO.	DESCRIPTION	SPECIAL PRICE
HSLCRWNMW217X1WHLN15W40K	9x24 inches 3750 Lumen w/2x15W LED T8 4000K Lamps Included	CALL
HSLCRWNMW417X1WHLN15W40K	17x24 inches 7500 Lumen w/4x15W LED T8 4000K Lamps Included	CALL
HSLCRWNMW232X1WHLN18W40K	9x48 inches 4200 Lumen w/2x18W LED T8 4000K Lamps Included	CALL
HSLCRWNMW432X1WHLN18W40K	17x48 inches 8400 Lumen w/4x18W LED T8 4000K Lamps Included	CALL

Change 40 to 35 or 50 for different Kelvin. Change Lamp Wattage to 9W on 2FT (1050L) or 15W on 4FT (1740). Consult for Alternate Wood Finishes.

For Emergency Option, see page K17.

**For Dimmable Version** - Change X1 to JLD MV and LN18W to LN18D  
 Adder 1 Light Fixture - \$17.50; Adder 2 Light Fixture - \$19.00;  
 Adder 3 Light Fixture - \$36.50; Adder 4 Light Fixture - \$38.00  
 Example: Item No. 131A432JLDMVLN18D40K 0-10V Dimming



**For Large Quantities, Call For Quote**



### Ideal for Residential Use

Change 40 to 35 or 50 for different Kelvin. Change Lamp Wattage to 2FT (1050L) or 15W on 4FT (1740).

### WRAPAROUND 7"

ITEM NO.	DESCRIPTION	SPECIAL PRICE
HSL207A217X1LN15W40	7" x 24" 3750 Lumen 2 Light Wraparound w/2x15W LED T8 4000K Lamps Included	CALL
HSL207A232X1LN18W40	7" x 48" 4200 Lumen 2 Light Wraparound w/2x18W LED T8 4000K Lamps Included	CALL
HSL207A332X1LN18W40	13" x 48" 6300 Lumen 3 Light Wraparound w/3x18W LED T8 4000K Lamps Included	CALL
HSL207A432X1LN18W40	13" x 48" 8400 Lumen 4 Light Wraparound w/4x18W LED T8 4000K Lamps Included	CALL



### WRAPAROUND 9"

ITEM NO.	DESCRIPTION	SPECIAL PRICE
HSL209A232AX1LN18W40	9" x 48" 4200 Lumen 2 Light Wraparound w/2x18W LED T8 4000K Lamps Included	CALL

Change 40 to 35 or 50 for different Kelvin. Change Lamp Wattage to 15W on 2FT or 15W on 4FT

### WRAPAROUND SPECIFICATION GRADE

ITEM NO.	DESCRIPTION	SPECIAL PRICE
HSL200A217X1LN15W40	11" x 24" 3750 Lumen 2 Light Wraparound w/2x15W LED T8 4000K Lamps Included	CALL
HSL200A232X1LN18W40	11" x 48" 4200 Lumen 2 Light Wraparound w/2x18W LED T8 4000K Lamps Included	CALL
HSL200A2328X1LN18W40	11" x 96" 8400 Lumen 4 Light Wraparound w/4x18W LED T8 4000K Lamps Included	CALL
HSL200A432X1LN18W40	16" x 48" 8400 Lumen 4 Light Wraparound w/4x18W LED T8 4000K Lamps Included	CALL
HSL200A4328X1LN18W40	16" x 96" 16800 Lumen 8 Light Wraparound w/8x18W LED T8 4000K Lamps Included	CALL

Change 40 to 35 or 50 for different Kelvin. Change Lamp Wattage to 9W on 2FT (1050L) or 15W on 4FT (1740).

### NARROW WRAPAROUND

ITEM NO.	DESCRIPTION	SPECIAL PRICE
HSL201A117X1LN15W40	5" x 24" 1875 Lumen 1 Light Wraparound w/1x15W LED T8 4000K Lamps Included	CALL
HSL201A132X1LN18W40	5" x 48" 2100 Lumen 1 Light Wraparound w/1x18W LED T8 4000K Lamps Included	CALL

Change 40 to 35 or 50 for different Kelvin. Change Lamp Wattage to 9W on 2FT (1050L) or 15W on 4FT (1740).

### CORRIDOR LINEAR

ITEM NO.	DESCRIPTION	SPECIAL PRICE
HSL159A117X1LN15W40	5" x 24" 1875 Lumen 1 Light Wraparound w/1x15W LED T8 4000K Lamps Included	CALL
HSL159A132X1LN18W40	5" x 48" 2100 Lumen 1 Light Wraparound w/1x18W LED T8 4000K Lamps Included	CALL
HSL159A1328X1LN18W40	5" x 96" 4200 Lumen 1 Light Wraparound w/2x18W LED T8 4000K Lamps Included	CALL

Change 40 to 35 or 50 for different Kelvin. Change Lamp Wattage to 9W on 2FT (1050L) or 15W on 4FT (1740).

**For Dimmable Version** - Change X1 to JLDMV and LN18W to LN18D  
 Adder 1 Light Fixture - \$17.50; Adder 2 Light Fixture - \$19.00;  
 Adder 3 Light Fixture - \$36.50; Adder 4 Light Fixture - \$38.00  
 Example: Item No. 131A432JLDMVLN18D40K 0-10V Dimming



**Consult for Fixtures Wired for LED T8 Lamps with Lamps Sold Separately**

For Emergency Option, see page K17.

**For Large Quantities, Call For Quote**

### BEST SELLER



### 2 OR 3 LIGHT STRIP 4.25"

ITEM NO.	DESCRIPTION	SPECIAL PRICE
HSLC217X1LI15W40	2ft. Strip 3750 Lumen 2x15W LED T8 4000K Lamps Included	CALL
HSLC317X1LI15W40	2ft. Strip 5625 Lumen 3x15W LED T8 4000K Lamps Included	CALL
HSLC232X1LI18W40	4ft. Strip 4200 Lumen 2x18W LED T8 4000K Lamps Included	CALL
HSLC332X1LI18W40	4ft. Strip 6300 Lumen 3x18W LED T8 4000K Lamps Included	CALL
HSLC2328X1LI18W40	8ft. Tandem Strip 8400 Lumen 4x18W LED T8 4000K Lamps Included	CALL

Change 40 to 35 or 50 for different Kelvin. Change Lamp Wattage to 9W on 2FT (1050L) or 15W on 4FT (1740).

### 1 LIGHT STRIP 2.75"



ITEM NO.	DESCRIPTION	SPECIAL PRICE
HSL117X1LI15W40	2ft. Strip 1875 Lumen 1x15W LED T84000K Lamps Included	CALL
HSL132X1LI18W40	4ft. Strip 2100 Lumen 1x18W LED T84000K Lamps Included	CALL
HSL1328X1LI18W40	8ft. Tandem Strip 4200 Lumen 2x18W LED T8 4000K Lamps Included	CALL

Change 40 to 35 or 50 for different Kelvin. Change Lamp Wattage to 9W on 2FT (1050L) or 15W on 4FT (1740).

### MINI STRIP (1.6 IN.) 1 LIGHT



ITEM NO.	DESCRIPTION	SPECIAL PRICE
HSLKDST8117X1LI15W40	1.6 " 2 ft. Strip 1875 Lumen 1x15W LED T84000K Lamps Included	CALL
HSLKDST8132X1LI18W40	1.6 " 4 ft. Strip 2100 Lumen 1x18W LED T84000K Lamps Included	CALL

Change 40 to 35 or 50 for different Kelvin. Change Lamp Wattage to 9W on 2FT (1050L) or 15W on 4FT (1740).

### 1 LIGHT LOW PROFILE STRIP



ITEM NO.	DESCRIPTION	SPECIAL PRICE
HSLLLS132X1LI18W40	49.5"L x 1.38"W . 1.69" 1 Light Strip w/LED T8 18W Lamp Included	CALL

Change 40 to 35 or 50 for different Kelvin. Change Lamp Wattage to 15W on 2FT or 15W on 4FT

For Emergency Option, see page K17

**For Dimmable Version** - Change X1 to JLDMV and LN18W to LN18D  
 Adder 1 Light Fixture - \$17.50; Adder 2 Light Fixture - \$19.00;  
 Adder 3 Light Fixture - \$36.50; Adder 4 Light Fixture - \$38.00  
 Example: Item No. 131A432JLDMVLN18D40K 0-10V Dimming



For Large Quantities, Call For Quote

## SIDE MOUNT STRIP



ITEM NO.	DESCRIPTION	SPECIAL PRICE
HLSM117X1LI15W40	2ft. Strip 1875 Lumen 1x15W LED T8 4000K Lamps Included	CALL
HLSM217X1LI15W40	2ft. Strip 5625 Lumen 2x15W LED T8 4000K Lamps Included	CALL
HLSM132X1LI18W40	4ft. Strip 2100 Lumen 1x18W LED T8 4000K Lamps Included	CALL
HLSM232X1LI18W40	4ft. Strip 4200 Lumen 2x18W LED T8 4000K Lamps Included	CALL

Change 40 to 35 or 50 for different Kelvin. Change Lamp Wattage to 9W on 2FT (1050L) or 15W on 4FT (1740).



## INDUSTRIAL

ITEM NO.	DESCRIPTION	SPECIAL PRICE
HSLIND232W30X1LI18W40	4ft. Industrial 4200 Lumen 2x18W LED T8 4000K Lamps Included	CALL
HSLIND332W30X1LI18W40	4ft. Industrial 6300 Lumen 3x18W LED T8 4000K Lamps Included	CALL
HSLIND2328W30X1LI18W40	8ft. Tandem Industrial 8400 Lumen 4x18W LED T8 4000K Lamps Included	CALL
HSLIND3328W30X1LI18W40	8ft. Tandem Industrial 12600 Lumen 6x18W LED T8 4000K Lamps Included	CALL

Change 40 to 35 or 50 for different Kelvin. Change Lamp Wattage to 15W on 2FT or 15W on 4FT

Order IND48WG \$9.20 for Wire guard.

## RECESSED STRIP ITB



ITEM NO.	DESCRIPTION	SPECIAL PRICE
HSLITB132X1LI18W40	4ft. Industrial 2100 Lumen 1x18W LED T8 4000K Lamps Included	CALL
HSLITB232X1LI18W40	4ft. Recessed Linear 4200 Lumen 2x18W LED T8 4000K Lamps Included	CALL
HSLITB1328X1LI18W40	8ft. Tandem Recessed Linear 4200 Lumen 2x18W LED T8 4000K Lamps Included	CALL
HSLITB2328X1LI18W40	8ft. Tandem Recessed Linear 8400 Lumen 4x18W LED T8 4000K Lamps Included	CALL

Change 40 to 35 or 50 for different Kelvin. Change Lamp Wattage to 15W on 2FT or 15W on 4FT

For Emergency Option, see page K17

**For Dimmable Version** - Change X1 to JLDMV and LN18W to LN18D  
 Adder 1 Light Fixture - \$17.50; Adder 2 Light Fixture - \$19.00;  
 Adder 3 Light Fixture - \$36.50; Adder 4 Light Fixture - \$38.00  
 Example: Item No. 131A432JLDMVLN18D40K 0-10V Dimming



For Large Quantities, Call For Quote



## PREMIERE HIGH BAY



ITEM NO.	DESCRIPTION	SPECIAL PRICE
HSLHBC432M23X1LN18W50	High Bay 48 inch 8400 Lumens w/4x18W LED T8 5000K Lamps Included	CALL
HSLHBC632M23X1LN18W50	High Bay 48 inch 12600 Lumens w/6x18W LED T8 5000K Lamps Included	CALL
HSLHBC832M23X1LN18W50	High Bay 48 Inches 16800 Lumens w/8x18W LED T8 5000K Lamps Included	CALL
HSLHBC1032M23X1LN18W50	High Bay 48 Inches 21000 Lumens w/10x18W LED T8 5000K Lamps Included	CALL
HSLHBC1232M23X1LN18W50	High Bay 48 Inches 25200 Lumens w/12x18W LED T8 5000K Lamps Included	CALL

Change 50 to 35 or 40 for different Kelvin. Change Lamp Wattage to 15W on 4FT.

## INDUSTRIALIZED GALVANIZED HIGH BAY



ITEM NO.	DESCRIPTION	SPECIAL PRICE
HSLHBG432M23X1LN18W50	High Bay 48 Inches 8400 Lumens w/4x18W LED T8 5000K Lamps Included	CALL
HSLHBG632M23X1LN18W50	High Bay 48 Inches 12600 Lumens w/6x18W LED T8 5000K Lamps Included	CALL
HSLHBG832M23X1LN18W50	High Bay 48 Inches 16800 Lumens w/8x18W LED T8 5000K Lamps Included	CALL
HSLHBG1032M23X1LN18W50	High Bay 48 Inches 21000 Lumens w/10x18W LED T8 5000K Lamps Included	CALL
HSLHBG1232M23X1LN18W50	High Bay 48 Inches 25200 Lumens w/12x18W LED T8 5000K Lamps Included	CALL

Change 50 to 35 or 40 for different Kelvin. Change Lamp Wattage to 15W on 4FT

## H6L SERIES



ITEM NO.	DESCRIPTION	SPECIAL PRICE
HSLH6L4328M23X1LN18W50	High Bay 96 Inches Tandem 16800 Lumens w/8x18W LED T8 5000K Lamps Included	CALL
HSLH6L432M23X1LN18W50	High Bay 48 Inches Tandem 8400 Lumens w/4x18W LED T8 5000K Lamps Included	CALL
HSLH6L6328M23X1LN18W50	High Bay 96 Inches Tandem 21000 Lumens w/10x18W LED T8 5000K Lamps Included	CALL
HSLH6L632M23X1LN18W50	High Bay 48 Inches Tandem 12600 Lumens w/6x18W LED T8 5000K Lamps Included	CALL

Change 50 to 35 or 40 for different Kelvin. Change Lamp Wattage to 15W on 4FT

For Emergency Option, see page K17

**For Dimmable Version** - Change X1 to JLDMV and LN18W to LN18D  
 Adder 1 Light Fixture - \$17.50; Adder 2 Light Fixture - \$19.00;  
 Adder 3 Light Fixture - \$36.50; Adder 4 Light Fixture - \$38.00  
 Example: Item No. 131A432JLDMLN18D40K 0-10V Dimming



**For Large Quantities, Call For Quote**



## H2L SERIES

ITEM NO.	DESCRIPTION	SPECIAL PRICE
HSLH2L132M23X1LN18W50	High Bay 48 Inches 2100 Lumens w/1x18W LED T8 5000K Lamps Included	CALL
HSLH2L232M23X1LN18W50	High Bay 48 Inches 4200 Lumens w/2x18W LED T8 5000K Lamps Included	CALL

Change 50 to 35 or 40 for different Kelvin. Change Lamp Wattage to 15W on 4FT.



Special red sockets to identify fixtures made for LED T8 lamps.

## BAFFLED HIGH BAY

ITEM NO.	DESCRIPTION	SPECIAL PRICE
HSLFHBL232X1LN18W50	Linear Louvered 48 Inches 4200 Lumens w/2x18W LED T8 5000K Lamps Included	CALL
HSLFHBL332X1LN18W50	Linear Louvered 48 Inches 6300 Lumens w/3x18W LED T8 5000K Lamps Included	CALL
HSLFHBL432X1LN18W50	Linear Louvered 48 Inches 8400 Lumens w/4x18W LED T8 5000K Lamps Included	CALL
HSLFHBL2328X1LN18W50	Linear Baffled Louver 96 Inches Tandem 8400 Lumens w/4x18W LED T8 5000K Lamps Included	CALL
HSLFHBL3328X1LN18W50	Linear Baffled Louver 96 Inches Tandem 12600 Lumens w/6x18W LED T8 5000K Lamps Included	CALL
HSLFHBL4328X1LN18W50	Linear Baffled Louver 96 Inches Tandem 16800 Lumens w/8x18W LED T8 5000K Lamps Included	CALL

Change 50 to 35 or 40 for different Kelvin. Change Lamp Wattage to 15W on 4FT.

## VAPOR TIGHT HIGH BAY WET LOCATION

(IDEAL FOR COLD STORAGE AND WASH DOWN) IP65, IP66 IP67, NEMA 4X



ITEM NO.	DESCRIPTION	SPECIAL PRICE
HSLCITA432X1LN18W40	14.61" x 51.91" Enclosure w/Clear Lens 8400 Lumen 4x18W LED T8 4000K Lamps Included	CALL
HSLCITA632X1LN18W40	14.61" x 51.91" Enclosure w/Clear Lens 12600 Lumen 6x18W LED T8 4000K Lamps Included	CALL

For Emergency add EM and \$100. See specification sheet for mounting options and accessories. C is Clear Acrylic Lens, change to FR for Frosted Acrylic Lens. For Polycarbonate Versions add PC after CL or FR. Available in 3000K, 3500K and 4000K.

For Emergency Option, see page K17.

**For Dimmable Version** - Change X1 to JLDLV and LN18W to LN18D  
 Adder 1 Light Fixture - \$17.50; Adder 2 Light Fixture - \$19.00;  
 Adder 3 Light Fixture - \$36.50; Adder 4 Light Fixture - \$38.00  
 Example: Item No. 131A432JLDLV18D40K 0-10V Dimming



For Large Quantities, Call For Quote

## Retrofit LED T8 Lamp Kit (Convert Existing Fluorescent Fixtures to LED)



UL Listed kit to bypass Fluorescent Ballast w/LED tubes.

Add "8" after RLK for tandem version and add \$2.00

To wire for Troffer Retrofit add "TR" after "RLK".

ITEM NO.	DESCRIPTION	SPECIAL PRICE
HSLRLK1X1WR	Retrofit Lamp Kit Prewired Unshunted Sockets For 1 LED T8 Lamp Includes Companion Sockets	CALL
HSLRLK2X1WR	Retrofit Lamp Kit Prewired Unshunted Sockets For 2 LED T8 Lamp Includes Companion Sockets	CALL
HSLRLK3X1WR	Retrofit Lamp Kit Prewired Unshunted Sockets For 3 LED T8 Lamp Includes Companion Sockets	CALL
HSLRLK4X1WR	Retrofit Lamp Kit Prewired Unshunted Sockets For 4 LED T8 Lamp Includes Companion Sockets	CALL
HSLRLK1X1WRLI18W40	Retrofit Lamp Kit Prewired Unshunted Sockets For 1 LED T8 Lamp Included Plus Companion Sockets	CALL
HSLRLK2X1WRLI18W40	Retrofit Lamp Kit Prewired Unshunted Sockets For 2 LED T8 Lamp Included Plus Companion Sockets	CALL
HSLRLK3X1WRLI18W40	Retrofit Lamp Kit Prewired Unshunted Sockets For 3 LED T8 Lamp Included Plus Companion Sockets	CALL
HSLRLK4X1WRLI18W40	Retrofit Lamp Kit Prewired Unshunted Sockets For 4 LED T8 Lamp Included Plus Companion Sockets	CALL

### Consult for Dimmable LED Lamps Retrofi Kit



**4 Ft. Wiring Harness**

(This kit will change a two lamp fluorescen to a dimmable two lamp with LED T8 lamps)



**LED Dimming Kit for 8 FT. Tandem 1 Light Strip**  
(Shown w/Optional Wiring Harness for Continuous Run)

## RETROFIT REFLECTOR KIT FOR PARABOLICS/TROFFERS



To wire for Troffer Retrofit

ITEM NO.	DESCRIPTION	SPECIAL PRICE
HSL22C2M20BL11X1LI15W40	2x2 Retrofit Kit 4200 Lumen Mirrored Reflection Includes 2x15W 4000K Lamps	CALL
HSL22C2W10BL11X1LI15W40	2x2 Retrofit Kit 4200 Lumen Enhanced White Reflection Includes 2x15W 4000K Lamps	CALL
HSL22C3M20BL11X1LI15W40	2x2 Retrofit Kit 6300 Lumen Mirrored Reflection Includes 3x15W 4000K Lamps	CALL
HSL22C3W10BL11X1LI15W40	2x2 Retrofit Kit 6300 Lumen Enhanced White Reflection Includes 3x15W 4000K Lamps	CALL
HSL24C2M20BL11X1LI18W40	2x4 Retrofit Kit 4200 Lumen Mirrored Reflection Includes 2x18W 4000K Lamps	CALL
HSL24C2W10BL11X1LI18W40	2x4 Retrofit Kit 4200 Lumen Enhanced White Reflection Includes 2x18W 4000K Lamps	CALL
HSL24C3M20BL11X1LI18W40	2x4 Retrofit Kit 6300 Lumen Mirrored Reflection Includes 3x18W 4000K Lamps	CALL
HSL24C3W10BL11X1LI18W40	2x4 Retrofit Kit 6300 Lumen Enhanced White Reflection Includes 3x18W 4000K Lamps	CALL

Change 40 to 35 or 50 for different Kelvin. Change Lamp Wattage to 15W on 2FT or 15W on 4FT.

**For Dimmable Version** - Change X1 to JLDLV and LN18W to LN18D  
 Adder 1 Light Fixture - \$17.50; Adder 2 Light Fixture - \$19.00;  
 Adder 3 Light Fixture - \$36.50; Adder 4 Light Fixture - \$38.00  
 Example: Item No. 131A432JLDLVLN18D40K 0-10V Dimming



For Large Quantities, Call For Quote

## BALLAST COVER RETROFIT KIT (Ideal to change 8ft Lamps to 4ft Tandem)



ITEM NO.	DESCRIPTION	SPECIAL PRICE
HSL4RB421T8L11X1LI18W40	4.25" Strip Retrofit Kit 48 In. 2100 Lumen Include 1x18W 4000K Lamp	CALL
HSL4RB422T8L11X1LI18W40	4.25" Strip Retrofit Kit 48 In. 4200 Lumen Include 2x18W 4000K Lamp	CALL
HSL4RB501T8L11X1LI18W40	5" Strip Retrofit Kit 48 In. 2100 Lumen Include 1x18W 4000K Lamp	CALL
HSL4RB502T8L11X1LI18W40	5" Strip Retrofit Kit 48 In. 4200 Lumen Include 2x18W 4000K Lamp	CALL
HSL8RB421X2T8L11X1LI18W40	4.25" Strip Retrofit Kit 96 In. 4200 Lumen Include 2x18W 4000K Lamp	CALL
HSL8RB422X2T8L11X1LI18W40	4.25" Strip Retrofit Kit 96 In. 8400 Lumen Include 4x18W 4000K Lamp	CALL
HSL8RB501X2T8L11X1LI18W40	5" Strip Retrofit Kit 96 In. 4200 Lumen Include 2x18W 4000K Lamp	CALL
HSL8RB502X2T8L11X1LI18W40	5" Strip Retrofit Kit 96 In. 8400 Lumen Include 4x18W 4000K Lamp	CALL

Change 40 to 35 or 50 for different Kelvin. Change Lamp Wattage to 15W on 2FT or 15W on 4FT

**Consult for Fixtures Wired for LED T8 Lamps with Lamps Sold Separately**

### How To Add Emergency to QUIK LED



Separate LED Array added for Emergency.



#### KEYSTONE KT-EMERG-LED-12-1200-K1 LED EMERGENCY LIGHTING KIT

**12W Constant Wattage - Ballast Battery Backup - Damp Location - 120-277V**  
Includes driver, separately housed 1200mAh Ni-Cd battery and 0.7" x 8" 1200 Lumen LED module for complete emergency lighting installations. When AC power fails, the driver will power the LED for a minimum of 90 minutes emergency illumination. Easy installation in existing LED or fluorescent fixtures with wiring diagrams and labels on all parts. Mounting hardware included. Full 5 year warranty on all components.  
Output Current 1000 mA-200mA - Output Voltage 12 ~41 Vdc

**To order, ADD: EMKT12 to end of X1LED item number and ADD \$100 to the fixture price for the EM. EM will be installed.**

### How To Add an Inverter to QUIK LED



**KT-EMRG-LED-5-500-AC**  
CONSTANT WATTAGE LED EMERGENCY BACK-UP

#### DESCRIPTION

LED Emergency Back-Up Driver | Standard Side Exit Wire Leads | 15W Output

<b>DRIVER TYPE:</b> Constant Wattage LED Emergency
<b>MAX. OUTPUT POWER:</b> 5W
<b>INPUT VOLTAGE:</b> 120-277Vac ±10%
<b>OUTPUT VOLTAGE:</b> 40-300Vdc
<b>OUTPUT CURRENT:</b> Load Dependant
<b>WARRANTY:</b> 5 Years

#### PRODUCT FEATURES

- Optimized for Keystone Single Ended Direct Drive LED tube
- Contact Keystone for details on functioning with other Type B LED tubes
- Illuminates entire LED load at reduced output under emergency mod
- One Piece Design with Metal Housin
- 2 -in- 1 LED test switch and indicator light include
- Evaluated to UL 924 requirement

**To order, ADD: INV5 to end of X1LED item number and ADD \$79 to the fixture price for the Inverter.**



## UNIVERSAL STRIP RETROFIT KIT

Choice of Reflectors or Ballast Cover

For ballast cover, choose strip width 4.25" or 5"



For enhanced light output add a mirrored specular reflector (M20) or white reflector (W10)

Universal socket bar SKRUSB is ideal to retrofit 4.25" to 5" strips with either reflector or ballast cover .



ITEM NO.	DESCRIPTION	SPECIAL PRICE
HLSKKB132B4L11X1LI18W40	4.25" Strip Retrofit Kit 48". 2100 Lumen Included 1x18W 4000K Lamps	CALL
HLSKKB232B4L11X1LI18W40	4.25" Strip Retrofit Kit 48". 4200 Lumen Included 2x18W 4000K Lamps	CALL
HLSKKB132B4L11X1LI18W40	4.25" Strip Retrofit Kit 96". 4200 Lumen Included 2x18W 4000K Lamps	CALL
HLSKKB232B4L11X1LI18W40	4.25" Strip Retrofit Kit 96". 8400 Lumen Included 4x18W 4000K Lamps	CALL
HLSKKB132B5L11X1LI18W40	5" Strip Retrofit Kit 48". 2100 Lumen Included 1x18W 4000K Lamps	CALL
HLSKKB232B5L11X1LI18W40	5" Strip Retrofit Kit 48". 4200 Lumen Included 2x18W 4000K Lamps	CALL
HLSKKB132B5L11X1LI18W40	5" Strip Retrofit Kit 96". 8400 Lumen Included 2x18W 4000K Lamps	CALL
HLSKKB232B5L11X1LI18W40	5" Strip Retrofit Kit 96". 4200 Lumen Included 4x18W 4000K Lamps	CALL
HLSKR132W10L11X1LI18W40	Strip Reflector Enhanced White Kit 48" 2100 Lumen Included 1x18W 4000K Lamp	CALL
HLSKR232W10L11X1LI18W40	Strip Reflector Enhanced White Kit 48" 4100 Lumen Included 2x18W 4000K Lamp	CALL
HLSKR1328W10L11X1LI18W40	Strip Reflector Enhanced White Kit 96" 4200 Lumen Included 2x18W 4000K Lamp	CALL
HLSKR2328W10L11X1LI18W40	Strip Reflector Enhanced White Kit 96" 8400 Lumen Included 4x18W 4000K Lamp	CALL
HLSKR132M20L11X1LI18W40	Strip Reflector Mirror Kit 48" 2100 Lumen Included 1x18W 4000K Lamp	CALL
HLSKR232M20L11X1LI18W40	Strip Reflector Mirror Kit 48" 4100 Lumen Included 2x18W 4000K Lamp	CALL
HLSKR1328M20L11X1LI18W40	Strip Reflector Mirror Kit 96" 4200 Lumen Included 2x18W 4000K Lamp	CALL
HLSKR2328M20L11X1LI18W40	Strip Reflector Mirror Kit 96" 8400 Lumen Included 4x18W 4000K Lamp	CALL
HLSKRUSB	UNIVERSAL BRACKET FOR SKR KIT	CALL

Change 40 to 35 or 50 for different Kelvin. Change Lamp Wattage to 15W on 2FT or 15W on 4FT

**UL Listed with all Options and Accessories.**

### Optional Dimming Options

The 4 FT. lamps are available with a dimming option. Specially designed dimming lamps require an external driver that runs up to 4 lamps. Dimming driver is installed in the fixture with dimming lamps to dim with 0-10V to 10%

**For Dimmable Version** - Change X1 to JLDMMV and LN18W to LN18D  
 Adder 1 Light Fixture - \$17.50; Adder 2 Light Fixture - \$19.00;  
 Adder 3 Light Fixture - \$36.50; Adder 4 Light Fixture - \$38.00  
 Example: Item No. 131A432JLDMMV LN18D40K 0-10V Dimming



**For Large Quantities, Call For Quote**



### WALL FIXTURE 4 FT.

ITEM NO.	DESCRIPTION	SPECIAL PRICE
HSL555MW232X1LN18W40	4ft. Wall 4200 Lumen 2x18W LED T8 4000K Lamps Included	CALL

### STAIRWELL 4FT. WITH ULTRASONIC SENSOR

ITEM NO.	DESCRIPTION	SPECIAL PRICE
HSLSS213A232X1LN18W40	4ft. Wall 4200 Lumen 2x18W LED T8 4000K Lamps Included	CALL

1 Light on Always, 1 Light on Sensor

### 4X4 LINEAR WALL



ITEM NO.	DESCRIPTION	SPECIAL PRICE
HSL44WSF117X1WHLN15W40	4" x 24" 1875 Lumen Pendant w/Cable Kit 1x15W LED T8 4000 Lamps Included	CALL
HSL44WSF217X1WHLN15W40	4" x 24" 3750 Lumen Pendant w/Cable Kit 2x15W LED T8 4000 Lamps Included	CALL
HSL44WSF132X1WHLN18W40	4" x 48" 2100 Lumen Pendant w/Cable Kit 1x18W LED T8 4000 Lamps Included	CALL
HSL44WSF232X1WHLN18W40	4" x 48" 4200 Lumen Pendant w/Cable Kit 2x18W LED T8 4000 Lamps Included	CALL
HSL44WSF1328X1WHLN18W40	4" x 96" 4200 Lumen Pendant w/Cable Kit 2x18W LED T8 4000 Lamps Included	CALL
HSL44WSF2328X1WHLN18W40	4" x 96" 8400 Lumen Pendant w/Cable Kit 4x18W LED T8 4000 Lamps Included	CALL

Change 40 to 35 or 50 for different Kelvin. Change Lamp Wattage to 15W on 2FT or 15W on 4FT  
 Change SF (Snap Fit Frosted Lens) to MW for Matte White Regressed Lens  
 Change WH to BK (Black), IR (Iron), SL (Silver) or BR (Bronze) add \$30 for 48" and \$50 for 96"  
 For Baffled Louve , Change MW to BL and add \$10.00

### 6X6 LINEAR WALL



ITEM NO.	DESCRIPTION	SPECIAL PRICE
HSL66WMW117X1WHLN15W40	6" x 26" 1875 Lumen Pendant w/Cable Kit 1x15W LED T8 4000 Lamps Included	CALL
HSL66WMW217X1WHLN15W40	6" x 26" 3750 Lumen Pendant w/Cable Kit 2x15W LED T8 4000 Lamps Included	CALL
HSL66WMW132X1WHLN18W40	6" x 48" 2100 Lumen Pendant w/Cable Kit 1x18W LED T8 4000 Lamps Included	CALL
HSL66WMW232X1WHLN18W40	6" x 48" 4200 Lumen Pendant w/Cable Kit 2x18W LED T8 4000 Lamps Included	CALL
HSL66WMW1328X1WHLN18W40	6" x 96" 4200 Lumen Pendant w/Cable Kit 4x18W LED T8 4000 Lamps Included	CALL
HSL66WMW2328X1WHLN18W40	6" x 96" 8400 Lumen Pendant w/Cable Kit 4x18W LED T8 4000 Lamps Included	CALL

Change 40 to 35 or 50 for different Kelvin. Change Lamp Wattage to 15W on 2FT or 15W on 4FT  
 Change WH to BK (Black), IR (Iron), SL (Silver) or BR (Bronze) add \$30 for 48" and \$50 for 96"  
 For Baffled Louve , Change MW to BL and add \$10.00

For Emergency Option, see page K17.



**For Dimmable Version** - Change X1 to JLDMMV and LN18W to LN18D  
 Adder 1 Light Fixture - \$17.50; Adder 2 Light Fixture - \$19.00;  
 Adder 3 Light Fixture - \$36.50; Adder 4 Light Fixture - \$38.00  
 Example: Item No. 131A432JLDMMV LN18D40K 0-10V Dimming



**For Large Quantities, Call For Quote**

## BED LIGHT (Direct and Indirect Light)

Special red sockets to identify fixtures made for LED T8 lamps.

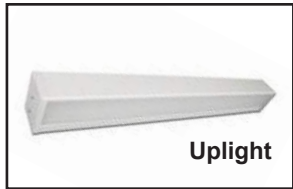

Add PC4 \$5.00 to switch up and down separately.

ITEM NO.	DESCRIPTION	SPECIAL PRICE
HSL215A1U1D17DFX1LN15W40	24" Direct/Indirect 3400 Lumens 2x15W LED T8 4000K Lamps Included	CALL
HSL215A1U1D32DFX1LN18W40	48" Direct/Indirect 3400 Lumens 2x18W LED T8 4000K Lamps Included	CALL
HSL215A1U2D17DFX1LN15W40	24" Direct/Indirect 5100 Lumens 3x15W LED T8 4000K Lamps Included	CALL
HSL215A1U2D32DFX1LN18W40	48" Direct/Indirect 6300 Lumens 3x18W LED T8 4000K Lamps Included	CALL
HSL215A2U1D17DFX1LN15W40	24" Direct/Indirect 5100 Lumens 3x15W LED T8 4000K Lamps Included	CALL
HSL215A2U1D32DFX1LN18W40	48" Direct/Indirect 6300 Lumens 3x18W LED T8 4000K Lamps Included	CALL
HSL215A2U2D17DFX1LN15W40	24" Direct/Indirect 6800 Lumens 4x15W LED T8 4000K Lamps Included	CALL
HSL215A2U2D32DFX1LN18W40	48" Direct/Indirect 8400 Lumens 4x18W LED T8 4000K Lamps Included	CALL

Change 40 to 35 or 50 for different Kelvin. Change Lamp Wattage to 15W on 2FT or 15W on 4FT  
Add SW4 and \$5.00 for 4 Way Switch

## CITADEL ENCLOSURES



ITEM NO.	DESCRIPTION	SPECIAL PRICE
HSLCITCL232X1LN18W40	4ft. Enclosure w/Clear Lens 4200 Lumen 2x18W LED T8 4000K Lamps Included	CALL
HSLCITCL332X1LN18W40	4ft. Enclosure w/Clear Lens 6300 Lumen 2x18W LED T8 4000K Lamps Included	CALL
HSLCITLB2328X1LN18W40	8ft. Enclosure w/Linear Ribbed Lens 8200 Lumen 4x18W LED T8 4000K Lamps Included	CALL

Change 40 to 35 or 50 for different Kelvin. Change Lamp Wattage to 15W on 2FT or 15W on 4FT  
Consult for different lens options and sensors.  
Change CL lens on 4ft to LB (linear ribbed) to match 8 ft. lens and add \$5.00

## WIDE BODY GARAGE LIGHT



ITEM NO.	DESCRIPTION	SPECIAL PRICE
HSLCITOL332 SBA3X1LN18W40	4 FT Deep Clear Enclosure 6300 Lumens with 4200 lumens for wide distribution and 2100 lumens for downlight. 3x18W LED T8 4000K lamps included. Surface Mounting brackets.	CALL
HSLCITOL332 SBA3X1LN18W40MDT4(21) (Pictured)	4 Ft Deep Clear Enclosure 6300 Lumens with 4200 lumens for wide distribution and 2100 lumens for downlight. 3x18W LED T8 4000K lamps included. Surface Mounting brackets and Occupancy Sensor included. Occupancy sensor wired to two wide area lamps.	CALL

MDT4 is for Standard Indoor Occupancy Sensor. For Wet Location change to MDT4W or for Cold Weather Sensor change to MDT4C and add \$13. Change 40 to 35 or 50 for different Kelvin. Change Lamp to 15W on 4FT Consult for different lens and mounting options.

**For Dimmable Version** - Change X1 to JLDVMV and LN18W to LN18D  
Adder 1 Light Fixture - \$17.50; Adder 2 Light Fixture - \$19.00;  
Adder 3 Light Fixture - \$36.50; Adder 4 Light Fixture - \$38.00  
Example: Item No. 131A432JLDMV/LN18D40K 0-10V Dimming



For Emergency Option, see page K17.

**For Large Quantities, Call For Quote**

## SPILL RING BATH



ITEM NO.	DESCRIPTION	SPECIAL PRICE
HSLHOTBD217X1SNLN15W40	2ft. Wall 3400 Lumen 2x15W LED T8 4000K Lamps Included	CALL
HSLHOTBD232X1SNLN18W40	4ft. Wall 4200 Lumen 2x18W LED T8 4000K Lamps Included	CALL

Change 40 to 35 or 50 for different Kelvin. Change Lamp Wattage to 15W on 2FT or 15W on 4FT

## PURPLE CAP BATH



ITEM NO.	DESCRIPTION	SPECIAL PRICE
VAN217X1LN15W40 (AL, SW, IV, BM, TO, WM)	2ft. Wall 3750 Lumen 2x15W LED T8 4000K Lamps Included	CALL
VAN232X1LN18W40 (AL, SW, IV, BM, TO, WM)	4ft. Wall 4200 Lumen 2x18W LED T8 4000K Lamps Included	CALL

Change 40 to 35 or 50 for different Kelvin. Change Lamp Wattage to 15W on 2FT or 15W on 4FT

## WALL PUFF



ITEM NO.	DESCRIPTION	SPECIAL PRICE
HSLWPU217X1LN15W40	2ft. Wall 3750 Lumen 2x15W LED T8 4000K Lamps Included	CALL
HSLWPU232X1LN18W40	4ft. Wall 4200 Lumen 2x18W LED T8 4000K Lamps Included	CALL

Change 40 to 35 or 50 for different Kelvin. Change Lamp Wattage to 15 W on 2FT or 15W on 4FT

## LED T8 LAMPS



### LED T8 LAMP CHOICES

### REDUCED PRICE

ITEM NO.	DESCRIPTION	SPECIAL PRICE
HSLLED24T815W1700LRK35K	LED T8 Lamp, Instafit or Bypass, 24In., 15W 1700 Lumen 3500	CALL
HSLLED24T815W1700LRK40K	LED T8 Lamp, Instafit or Bypass, 24In., 15W 1700 Lumen 4000	CALL
HSLLED24T815W1700LRK50K	LED T8 Lamp, Instafit or Bypass, 24In., 15W 1700 Lumen 5000	CALL



Consult for U-Bend, Dimmable and other T8 LED Lamp Options

ITEM NO.	DESCRIPTION	SPECIAL PRICE
HSLLED48T815W1800LRK35K*	LED T8 Lamp, Instafit or Bypass, 48In., 15W 1800 Lumen 3500	CALL
HSLLED48T815W1800LRK40K*	LED T8 Lamp, Instafit or Bypass, 48In., 15W 1800 Lumen 4000	CALL
HSLLED48T815W1800LRK50K*	LED T8 Lamp, Instafit or Bypass, 48In., 15W 1800 Lumen 5000	CALL
HSLLED48T818W2100LRK35K	LED T8 Lamp, Instafit or Bypass, 48In., 18W 2100 Lumen 3500	CALL
HSLLED48T818W2100LRK40K	LED T8 Lamp, Instafit or Bypass, 48In., 18W 2100 Lumen 4000	CALL
HSLLED48T818W2100LRK50K	LED T8 Lamp, Instafit or Bypass, 48In., 18W 2100 Lumen 5000	CALL

Consult for Fixtures Wired for LED T8 Lamps with Lamps Sold Separately

### About T8 LED Lamps

Our T8 LED lamps are available in 2 or 4 ft. sizes in different wattages, lumens and color temperature options.

- 50,000 Hour Life with 5 Year Warranty
- Beam Angle 140 Degree
- Aluminum Base and Aluminum Housing with Glass Cover
- Operating Temperature: -20°C to 50°C
- Color Temperature: 3500K, 4000K, 5000K
- G13 Pins (Same as Fluorescent Linear T8 Bipins)
- AC100 - 277V without Ballast
- Single Ended Power

**SG**  
Ask for Savegreen  
Lamps inside

Savegreen now available in new Wattage and Lumen Options including a Bypass High Lumen Lamp. Call for more information.